

**Operating manual**

# **Unichiller in Tower Housing with CC-Pilot**

**11.01.2010**

**Also for models with natural refrigerant (NR)  
Also for models with heating**

**Valid for:**

**UC017T, UC020T, UC026T, UC040T, UC045T  
UC055T, UC060T, UC080T, UC100T, UC110T**

**UC017Tw, UC020Tw, UC025Tw, UC030Tw, UC040Tw  
UC055Tw, UC060Tw, UC080Tw, UC100Tw, UC110Tw  
UC130Tw, UC150Tw, UC160Tw, UC200Tw, UC210Tw,  
UC250Tw, UC260Tw, UC300Tw, UC400Tw, UC500Tw**



# Contents

V1.4/01.10 // software: V06.10.001

<b>Foreword</b> .....	<b>4</b>
<b>Quick guide for CC-thermostats</b> .....	<b>5</b>
<b>Chapter 1: Safety</b> .....	<b>7</b>
Description of Safety and Information symbols .....	8
Intended Use and General Safety Instructions .....	9
Description .....	10
Duties of responsible person .....	11
Operator requirements .....	11
Machine operator duties .....	11
Work area .....	11
Safety Devices to DIN12876 .....	12
Additional Protection Devices .....	13
Environmental Conditions .....	14
Operating conditions .....	15
Location .....	16
Thermofluids .....	17
<b>Chapter 2: Electronics and operation</b> .....	<b>18</b>
CC-Pilot .....	19
Information Displays CC .....	20
Description of individual Fields .....	21
Real-time clock .....	23
Event Function .....	23
Operation CC .....	24
CC Operation using the rotary knob .....	25
CC Operation using the simulated Number Pad .....	26
Main menu .....	27
Comfort menu .....	36
ComG@te menu .....	43
Function Numbers and their meaning .....	49
Configure User menus .....	55
Select User menu .....	56
<b>Chapter 3: Connect the machine, fill and prepare for the required application</b> .....	<b>57</b>
Power connection .....	58
Safety instructions .....	58
Start up .....	58
Freezing protection (only valid for temperature control units with the option freezing protection) .....	58
Water-cooling (valid for units with water cooling) .....	59
Connecting an externally closed application .....	60
Switching on the temperature control unit .....	60
Setting the over-temperature (OT) switch .....	61
Setting the level indicating meter with capacitive level identification .....	63
Setting the set point limits .....	65
Entering a set point .....	65
Starting CC Temperature control .....	65
Ending CC Temperature control .....	66

Filling and air purging an externally closed system .....	67
Draining the machine and an externally closed application.....	68
Changing heat transfer fluid / internal cleaning .....	68
<b>Chapter 4: Interface and software update .....</b>	<b>69</b>
ComG@te.....	70
Digital Interface with addition NAMUR-Commands .....	72
<b>Chapter 5: First aid for a fault condition.....</b>	<b>74</b>
Messages .....	75
Display Error Messages.....	76
Alarm and Warning codes .....	77
Exchange of the CC Electronics / Remote Control .....	80
Remote Control: .....	80
Maintenance .....	81
Decontamination / Repair .....	82
Cleaning the surfaces .....	82
Plug contacts .....	82
<b>Chapter 6: Taking the machine out of service.....</b>	<b>83</b>
Decommissioning.....	84
Transport.....	85
Disposal .....	85

## Foreword

Dear Customer,

The Huber team would like to thank you for ordering this product. You have made a good choice. We thank you for your trust!

Please read and understand the instruction manual thoroughly before operating the unit. All instructions and safety information must be complied with.

Please read this manual before transporting, commissioning, operating, maintaining, repairing, storing or disposing of this unit.

Failure to comply with the instructions within this manual may invalidate any warranty for this unit.

# Quick guide for CC-thermostats

## Checklist for initial operation:

1. Make sure that the machine is connected correctly and enough thermal fluid is inside.
2. Switch on the unit via the mains switch!
3. Make sure that the over-temperature is set correctly.
4. Make sure that the set-point limits (min and max) are set correctly.
5. Enter e.g. a new set-point!
6. Make sure that you have set the correct temperature mode (e.g. process)!
7. Start temperature control!

## Operation:

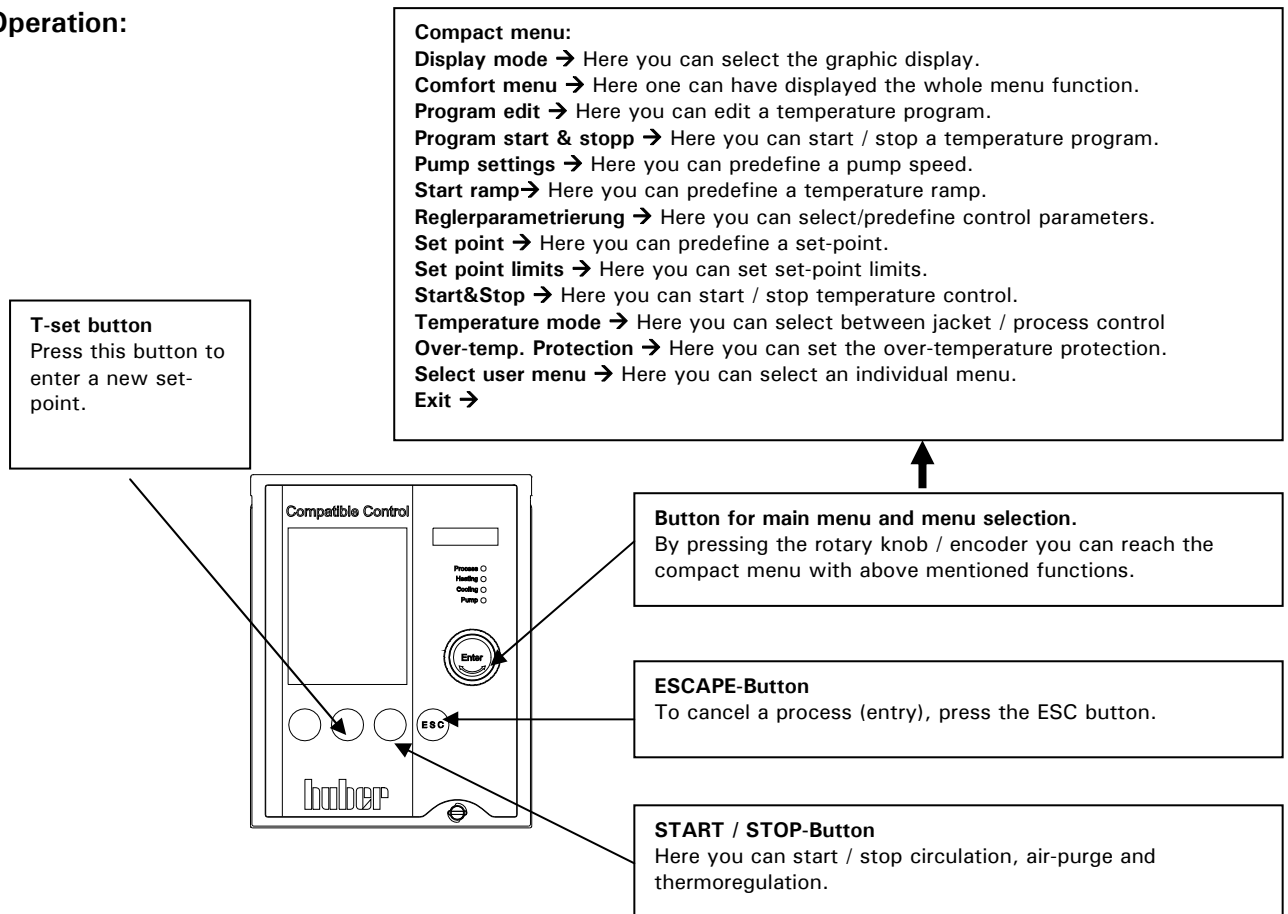

## Setting the over-temperature protection:

1. Select the function over-temperature from the compact menu!
2. Select the menu point, setting the over-temperature protection!
3. To adjust the over-temperature a code is being given out via the display for several seconds.
4. You are being requested to enter a code!
5. Enter the code which has been displayed previously!
6. The over-temperature can be adjusted if the code has been entered correctly!
7. The new over-temperature value will be now displayed!

## ComG@te allocation and setting (quick guide)

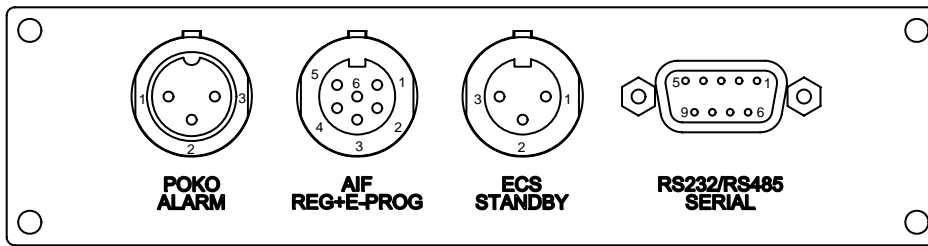

### PoKo (potential free contact) Alarm plug-in connector

Signal contact for external monitoring.

The connection is designed as a potential free changeover contact.

Normally open contact between pin 1 and pin 2. Normally closed contact between pin 2 and pin 3.

Contact load: 1A at 24V DC Only use screened lines!

### AIF Reg-E-Prog Socket

Analogue interface, one input channel (programmable) and 3 output channels.

Pin	Signal
1. Current output, T extern	0/4-20mA or 0-10V
2. Current output, Set point	0/4-20mA or 0-10V
3. GND for analogue outputs	GND
4. Analogue input (programmable)	0/4-20mA or 0-10V
5. Current output, free programmable	0/4-20mA or 0-10V
6. GND for analogue input	GND

### ECS Socket (External Control Signal) Standby

Release signal ECS (External Control Signal), for starting / stopping temperature control.

The following variants are offered:

Pin	Signal
1,3	E2
2	E1

### RS232 / RS485 Serial Socket

Wiring RS232:			Wiring RS485	
Pin2	RxD	Receive Data	Pin6	A with 120 Ohm load resistance
Pin3	TxD	Transmit Data	Pin7	A
Pin5	GND	Signal GND	Pin8	B

### Functions in connection with PLS

Settings for analogue interface, release signal, signal contact and digital interface RS232 / RS485 can be made via the functions analogue interface, ext. control signal, pot. free contact and dig. interface in the comfort menu!

#### Standard settings are:

Analogue interface: analogue input OFF and analogue output OFF

Ext. control signal (ECS): No action

Pot. free contact (POKO/ALARM): no alarm

Dig. interface: RS232 with Baudrate 9600

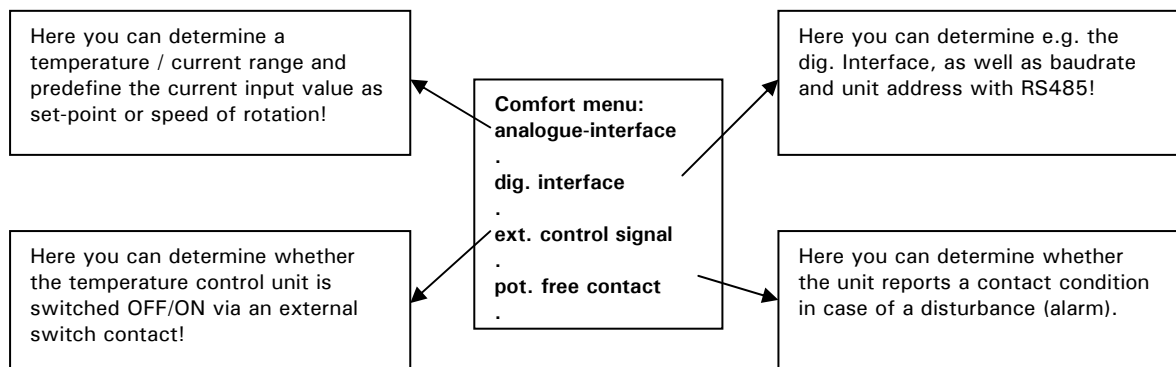

# Chapter 1: Safety

In this chapter is to be found the following sections:

- Description of safety and information symbols
- Intended use and General Safety Information
- Description
- Duties of the responsible person
- Operator requirements
- Machine operator duties
- Work area
- Safety Devices to DIN 12876 (applicable for units with heating)
- Additional Protection Devices (if provided)
- Environmental conditions
- Operating conditions
- Location
- Thermofluids



# Description of Safety and Information symbols

Safety information is shown with a pictogram and keyword. The keyword indicates the level of the corresponding danger.



<b>Danger!</b>	Immediate risk to the life and health of personnel (Serious injury or death).
<b>Warning!</b>	Possible risk to the life and health of personnel (Serious injury or death).
<b>Caution!</b>	Possible dangerous situation (possible injury to personnel or damage to property).



<b>Information!</b>	User-tips and other useful information.
---------------------	---



<b>Requirement!</b>	Requirement to carry out a specific method, or action, for safe machine operation.
---------------------	--

## Intended Use and General Safety Instructions



**Danger!**

**Non-intended use can result in considerable personal injuries and material damage.**

No third persons are authorized to make any changes to the machine. The device declaration becomes void, if any modification is carried out without manufacturers consent. Only personnel trained by the manufacturer may carry out modifications, repairs or maintenance work.

### **The following must be observed:**

Always use the machine in a perfect working condition!

Only expert personnel may initially start-up and repair the device!

Do not bypass, bridge-over, dismantle or switch off the safety mechanisms!



The manufacturer is not liable for damages caused by technical changes to the temperature control device, inappropriate handling and / or use of the temperature control device without regard to the operating instructions.

The temperature control device is manufactured for commercial use only and may **only be used to maintain the temperature** within the internal bath (does not apply for chillers) and to **maintain the temperature** of reactors or other professionally expedient objects in laboratories and industry. Suitable thermal fluids are used throughout the entire system. The refrigerating or heating capacity is provided at the pump connections and in the bath itself (does not apply for chillers). The technical specifications of the temperature control device are determined in the data sheet. Operation must be prepared and carried out according to the operating instructions. Any non-observance of the operating instructions is considered as non-intended use.

The temperature control device corresponds to the state-of-the-art and the recognized safety-related regulations. Safety devices are built into your temperature control device.

The device is **NOT** approved for use as a medical product!



This temperature control unit is **NOT** built as explosion-proof and is **NOT** suitable for use in "ATEX" areas!

### **Foreseeable non-intended use:**

- Activate the brakes for machines with rollers or roller support.

## Description

This temperature control machines have been designed to be used with **external closed systems**.

The **low internal volume** combined with **high performance refrigeration** technology, gives a **very short cooling time**.

With the integrated **speed controlled pump** fitted in the table models and some floor standing models, it is possible to control **flow** and / or **pressure** of the thermal fluid and thus can be exactly adapted for the required application.

With help of the **self optimising cascade controller**, you obtain the **optimum control results** under steady state conditions as well as by **set point changes** and with **exothermic reactions**. One can choose between aperiodic or with a small overshoot (faster) control.

Information and temperature development can be **easily read** via the **large graphic display screen (with touch screen)** as well as give command inputs.

A **comfortable menu guidance** eases the operation of the machine. The software package **Basic, Exclusive** and **Professional** offer high functionality and comfort in usage for users with simple temperature control tasks up to demanding temperature control tasks. For a small extra charge the functionality can be extended by **E-grade**. Here you have the possibility to upgrade your package from **Basic** to **Professional** via an **activation key** (please contact our Customer Support)

The optional **ComG@te** with the **digital interfaces RS232, RS485**, the **analogue 0/4-20mA or 0-10V interface** as well as **various digital in and output possibilities (all according to the NAMUR)**, and fitted as standard, the machine (valid for Basic, Exclusive and Professional) can be fitted without problem into many laboratory automation systems

The **removable CC-Pilot** can be used as a **remote control**.

**External temperature control requirements** can be easily met (requirement E-grade Exclusive or Professional) via the external **Pt100 connection (NAMUR standard)**

The **integrated temperature-ramp function** as well as the **internal programmer** underline the high level of operator comfort. The integrated programmer offers the possibility of 3 different temperature programs each with 5 program steps (E-grade Exclusive) or 10 different temperature programs with a maximum of 100 steps (E-grade Professional), which can be made and then called up.

The thermostat uses an **over-temperature protection** in accordance with **DIN EN 61010-2-010**, which is **independent** of the actual control circuits.

## Duties of responsible person



The operating instruction is to be kept easily accessible and in immediate vicinity of the unit. Only suitably qualified personnel should operate this unit. Personnel should be properly trained before operating the unit. Make sure that the operators have read and understood the instruction manual. Supply appropriate Personal Protective Equipment as required.

## Operator requirements



Only authorised personnel should operate this unit. Personnel should be properly trained before operating the unit. The minimum age for operators is 18 years. Personnel under 18 years should only operate the unit under the direct supervision of qualified personnel. The operator is responsible for third parties within the working area.

## Machine operator duties



Make sure that the operators have read and understood the instruction manual. Please observe the safety instructions. Appropriate Personal Protective Equipment (e.g. safety goggles, safety gloves) should be worn when operating the unit.

## Work area

Work area is defined as the area in front of the machines control panel. Work area is determined by the peripheral equipment connected by the operator.

It is the customer's responsibility to ensure a clear, safe working area around the temperature control unit. The arrangement of the work area should be made after considering access to, and risk assessment of, the area and application.

## Safety Devices to DIN12876

- Low level switch
- Adjustable over-temperature switch (also valid for chillers with heating)

**Classification of Laboratory Thermostats and Baths**

Classification	Thermal Fluid	Technical requirement	Designation <sup>d</sup>
I	non-flammable <sup>a</sup>	Over-temperature cut-off <sup>c</sup>	NFL
II	flammable <sup>b</sup>	Adjustable over-temperature cut-off	FL
III		Adjustable over-temperature cut-off and extra low-level switch	

<sup>a</sup> Normally water; other fluids only when they are non-flammable in the event of a single Failure.

<sup>b</sup> The thermal fluid must have a flame point  $\geq 65$  °C, this means that ethanol can only be used under constant supervision.

<sup>c</sup> The over-temperature protection can for example be provided by a fluid sensor or a suitable over temperature switch.

<sup>d</sup> Determined by the manufacturer.

Your temperature control unit is designated a Class III FL.

### **ELO: Electrical Over-temperature Switch**

This temperature control unit is equipped with an electronical over-temperature switch and low level protection. Instead of a mechanical float switch temperature sensors are mounted on the surface of the heating coils to monitor the over-temperature at a potential ignition source and to ensure that the critical temperature at the heating coils (burn point of the thermal fluid) is controlled by the controller (not valid for chillers, liquid level is determined by electrical capacity) via the graphical display (60) error message will be given out.

A mechanical tool is no longer required to change the over-temperature settings. The over-temperature switch can only be adjusted after the user has re-entered a code displayed on the CC-Pilot´s display (60). This procedure avoids unintentional changes being made to the setting and replaces a mechanical tool by software.



A new feature is the **Process Safety** function. This function provides further protection for the operators and application. A classic over-temperature device unit would trip and cause a shutdown if over-temperature cut-off temperature was reached. This could occur under circumstances where more heat was being generated by a process (exothermic) than the unit could remove. Switching the temperature control unit off would remove the only possible method of cooling the application down. Consequently, the temperature would be able to further increase, creating a risk of injury to personnel or damage to the application, for example by over-heating a liquid into pressurised vapour.

Using the **Process Safety** function, the controller recognises when the over-temperature cut-off is reached, and switches the cooling on. The compressor control is automatically set to **always on**. Even if the temperature continues to rise, the refrigeration system will increase its cooling to maximum to minimise the heating. Please also note chapter on setting the **Over-temperature**.

## Additional Protection Devices

- Autostart function
- Alarm function
- Warning messages
- General unit messages



**Danger!**

**Emergency Procedure: Disconnect Electrical Power!**

Turn the Mains isolator (36) to "0"!

Dangerous liquid / vapours from temperature control unit or connected hoses (very hot, very cold, dangerous chemicals) and / or fire / explosion / implosion:

Evacuate the area, following local regulations and procedures to prevent injury or loss of life! Refer to the MSDS Safety information for the thermal fluid concerned!

## Environmental Conditions



This unit, and operations, will comply with DIN EN 61010-1:2001, only when it is located in suitable environmental conditions.

- for indoor use only;
- installation site  $\leq$  2000 m altitude;
- installed on a level, even, non flammable surface;
- maintain a clearance above and around the unit of 10 cm for water-cooled units, and 20cm for air-cooled units, to allow air to circulate around the unit;
- for ambient temperature conditions please refer to the technical data sheet; remaining within these ambient conditions is imperative in ensuring accurate operation;
- maximum relative humidity of 80% up to 32°C, decreasing linearly to 50% relative humidity at 40°C
- use only as long a power cord as necessary;
- the unit should be located so as not to restrict access to the mains power switch;
- mains voltage should be  $\pm 10\%$  of the rated value;
- avoid voltage spikes;
- transient voltage surges as they occur normally in the supply grid;
- clean rating 2;
- overvoltage category II

## Operating conditions



Please make sure that the application and system performance is dependent upon the temperature range, viscosity, and flow rate of the thermal fluid:

- Please ensure that the power supply connections are correctly dimensioned.
- The temperature control device should be located so, that sufficient fresh air is available even when working with water cooled units.
- Please note that hose connections should be compatible with the thermal fluid used and the working conditions.
- When choosing the thermal fluid, not only minimal and maximum temperatures have to be complied with but also have to be suitable regarding burn point, viscosity and / or freezing. Furthermore the thermal fluid has to be compatible with all the materials used in the unit.
- Pressure changes with the length of hoses (keep as short as possible). Choose as large a diameter of hoses as possible (the width of the pump connections are considered as a point of reference) and may negatively affect temperature control results. Flow restrictions may occur if a too narrow connector is selected for corrugated hoses.
- The use of unsuitable hoses or hose connections may cause thermal and toxic injury to personal and environment. Temperature control hoses and their connections have to be insulated / secured against contact / mechanical damage.
- Non-suitable thermal fluids can negatively affect temperature control and be the cause of negative temperature results and damages. Therefore only use the thermal fluids recommended by the manufacturer and only in the intended temperature and pressure range. The application should be located on approximately the same level or lower than the temperature control device, if temperature control is to be carried out near to the boiling temperature of the thermal fluid. The thermal fluid should have room temperature when filling. Fill in the thermal fluid slowly, carefully and steadily. At the same time make sure that no thermal fluid overflows (back pressure); it is thereby necessary to wear personal protective equipment, e.g. safety goggles, thermally and chemically resistant gloves, etc.
- After filling and setting all necessary parameters the thermoregulation circuit has to be degassed. This is a requirement for proper operation of the device and thus its application.
- In the case of pressure-sensitive applications, e.g. glass reactors, observe the maximum inlet pressure of the temperature control device for cross section reduction or shut-off (see data sheet). Take suitable precautions (e.g. pressure limitation for temperature control devices with pressure control, bypass).
- In order to avoid danger of overpressure in the system, which could damage the temperature control device or the application, the thermal fluid must always be adapted at room temperature before turning off and a possibly available shut-off valve must be left open (pressure compensation).
- Temperature and dynamics within the reactor are determined by the outlet temperature. A differential temperature is created ( $\Delta T$ ) between outlet temperature and the temperature within the reactor. This difference in



temperature has to be adapted, depending upon type of glass application. As the differential temperature may exceed the admissible limit values and bursts may occur. Delta T value has to be adapted to the corresponding application. Therefore please see chapter **Comfort menu**.

- Do not kink the hoses.
- Check hoses in regular intervals for material fatigue (e.g. cracks).

With water cooled units please pay special attention to the maximum operating temperature and differential pressure requirements for the cooling water. Therefore please refer to the technical data sheet.



### **Danger!**

If the cooling water contains high levels of minerals, e.g. chloride, bromide then suitable water treatment chemicals should be used. Use only recommended materials to maintain the unit warranty. Further information on corrosion, (appearance and avoidance) can be found on our website [www.huber-online.com](http://www.huber-online.com) under "Download / Safety data sheets thermofluids / Characteristics of water".



Please refer to the sections on **Intended use and general safety instructions**.

## **Location**



### **Caution!**

- Transport the unit upright.
- The unit should be mounted in an upright and secure position, on a solid, stable surface.
- Place on a non flammable surface.
- Keep the area around the unit clean, to avoid slip and trip hazards.
- Set the brakes on the castors once the unit is in position.
- Place suitable absorbent material under the unit to catch any condensate and thermal fluid spills.
- Any spillage of thermal fluid should be immediately cleaned up.
- For large units, check the weight / load capacity for the flooring

## Thermofluids



We recommend the thermal fluid shown in our catalogue. The name of a thermal fluid is derived from the working temperature range and the viscosity at 25 °C.

Examples of thermal fluids in our catalogue:

M40.165.10:

- Lower working limit -40 °C
- Upper working limit 165 °C
- Viscosity at 25 °C: 10 mm<sup>2</sup>/s

The data sheet for the thermal fluid used is of utmost importance, and must be read before use. This data sheet should be followed.

- Please note the classification of your machine according to DIN 12876
- The chosen thermal fluid must be compatible with stainless steel 1.4301 (V2A) and FKM!
- The maximum viscosity of the thermal fluid may not exceed 50 mm<sup>2</sup>/s at the lowest temperature reached!
- The maximum density of the thermal fluid may not exceed 1kg / dm<sup>3</sup>
- For chillers we recommend as thermal fluid a mixture of water and glycol (a mixture is recommended that permits a temperature down to -25°C). Information on water quality can be found on our website ([www.huber-online.com](http://www.huber-online.com)) under "Download / Safety data sheets thermofluids / Characteristics of water".

## Chapter 2: Electronics and operation

The following sections are to be found in this chapter:

- CC-Pilot
- Information display
- Real time clock
- Operation
- Operation using the rotary knob
- Operation using the simulated Number Pad
- Main menu points
- Compact menu
- Comfort menu
- ComG@te menu
- Function numbers and their meaning
- Select user menus

# CC-Pilot

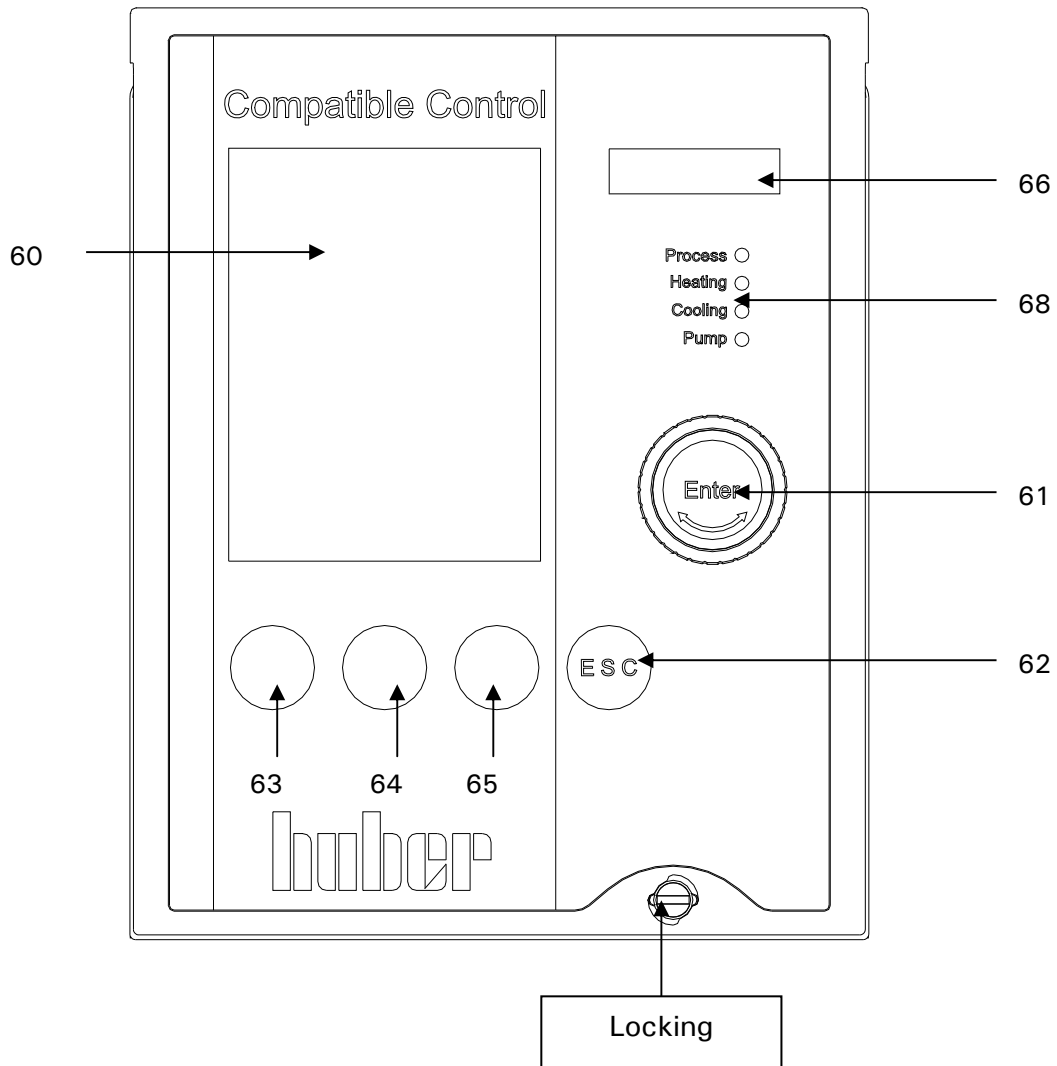

- 60) Touch screen and graphic display
- 61) Key and rotary knob
- 62) ESC key
- 63) Key 1 (Soft-key 1)
- 64) Key 2 (Soft-key 2)
- 65) Key 3 (Soft-key 3)
- 66) LED temperature display
- 68) LED status display

# Information Displays CC

The following information displays are available:

1. Graphical display (60)
2. LED temperature display (66)
3. LED status display (68)

## 1. Graphical display (60)

The most important display, giving details of standard parameters (set point, current temperature, set point limits), as well as menu options and error messages.

## 2. LED temperature display (66)

The red LED display shows the current over-temperature limit. Please note that if the temperature of the temperature control devices reaches this value, the unit will perform a <safety cut-off!>. The green LED display shows the current temperature, being controlled. Please note that in internal control mode the internal temperature (outlet temperature / jacket temperature) will be shown, and with cascade control mode the process temperature (reactor temperature) will be shown.

## 3. LED status display (68)

These LEDs summarise the status information shown in point 2 above.

Screen display (this display is reached by selecting Main Menu / Display Mode / Graphic)

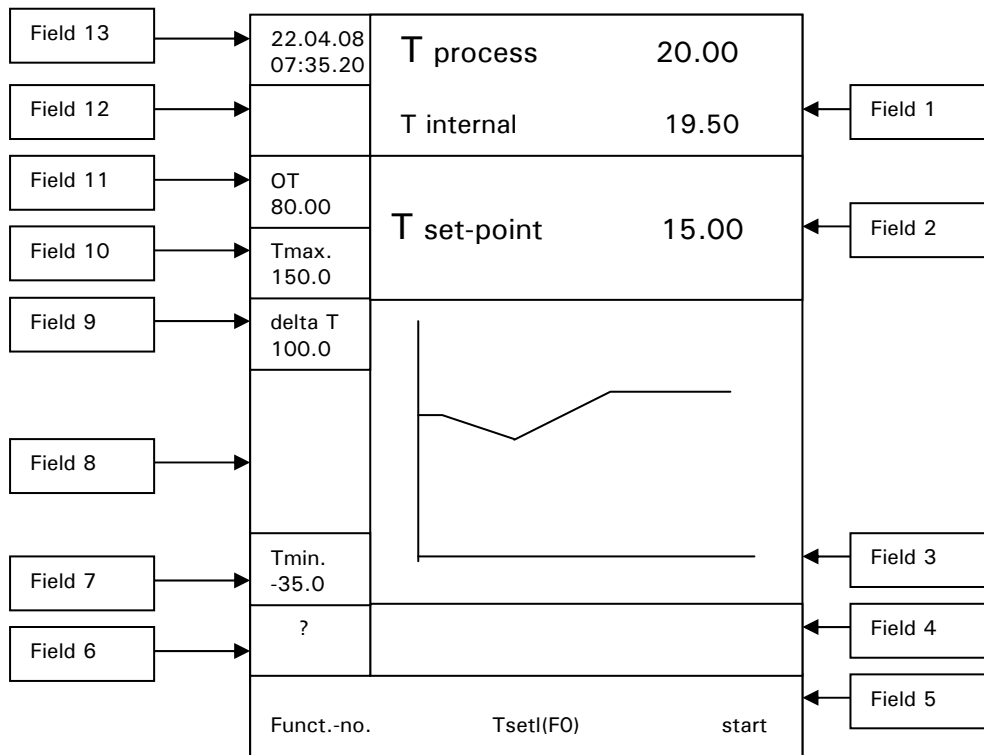

Please also note operating options described in chapter **operation**.

## Description of individual Fields

### Field 1: Display Current value

This field shows the current internal temperature of the unit and, if an external sensor is connected, the current process temperature.

### Field 2: Display Set point

This field displays the current set-point.

### Field 3: Display Graphic temperature

This field shows the internal and process temperatures in graphical format. The span of the temperature axis is between the minimum (see field 7) and maximum set-point limits (see also field 10).

### Field 4: Display Status Field

This field shows useful information such as the current temperature control mode (internal or process), unit operations (degassing, air-purging) and active control loops.

### Field 5: Display Soft-keys operation

This field enables various functions. Please therefore note the soft keys (63, 64, 65) located directly under the relevant touch screen buttons. The Function Number menu can be displayed by lightly touching the soft key 63 Funct.-no area of the screen. Please refer to the **Function Numbers and Definitions** chapter for more details.

Pressing the soft key (64) Tset F(0) area of the screen will bring up the option to enter a new set-point. Pressing the soft key 65 Start of the screen will bring up the **Start & Stop menu**. This menu allows the temperature control, air-purging, circulation and degassing to be started as required. After an operation, the menu will return to the standard screen. Instead of the function Start in field 5 the function stop is now available. Pressing the soft key 65 Start of the screen will bring up the **Start & Stop menu** again. By pressing the Start area again, any operations previously started may be stopped.

### Field 6: Display Help

Help (general information / trouble-shooting information) will be displayed.

### Field 7: Display Minimum set point

This field displays the current minimum set point limit (corresponds to Funct. no. F1). The minimum set point also serves as the lower temperature limit for the graphic temperature display, in Field 3.

### Field 8: Pump and Level information

This field displays the level as well as pump status including pump speed indication (only for temperature control devices with speed regulation).

### Field 9: Display delta T

This field displays the delta T value (max. admissible difference between process and internal temperature). This value may be set within a range of 0...100K under the main menu point limits / delta T limits. This field is active only with a connected process sensor and when the temperature mode process temperature is activated.

**Field 10: Display Maximum set point**

This field displays the current maximum set point limit (corresponds to Funct. no. F2). The minimum set point also serves as the upper temperature limit for the graphic temperature display, in Field 3.

**Field 11: Display Over-temperature cut-off**

This field displays the current setting of the over-temperature cut-off. Please note that this value can only be changed through the **Main menu Over-temperature**. Please refer to the **Setting the over-temperature** chapter in the **Main menu**.

**Field 12: Display Alarm and Warning messages**

This field displays information on any alarm or warning conditions that are present. Alarm and warning messages are also immediately displayed as text in the graphic display (60).

**Field 13: Display Date and Time**

This field displays the current date and time.

## **Real-time clock**

### **Rechargeable Battery**

The Unistat Pilot as well as CC-Pilot (for temperature control devices with CC-Pilot) are equipped with an internal, battery-powered clock that runs even when the unit is turned off. When the unit is powered up, the actual date and time are uploaded to the unit. The capacity of the battery means allows the clock to continue to run for a number of months. If a unit has been powered-down for an extended time, it should be powered-up and left for an hour or so before running it again. If the time and date have been lost, they can be re-entered during this period.

If after turning off and on again, the time and date have been reset, then it must be assumed that there is a problem with the rechargeable battery. In this case please contact our service department.

### **Event Function**

The clock has a programmable event function. Using this function an operation can be set to run every day (until the function is reset in the operator menu). There are two available operations:

**Audible tone:** The unit will generate an audible tone for about 15 seconds.

**Program Start:** When configuring the calendar to start a program, the user will be asked for the number of the program to be started. The program will then be started at the set time and date, even if (manual) temperature control had not been previously started.



## Operation CC

Please note, there are multiple possibilities to operate the machine.

1. **Operation via function keys T1 to T3 (63, 64, 65)**, together with information given in the lowest line of the graphic display (60).
2. **Operation via the rotary selector / key (61)**, together with the information given via the graphic display (60).

Note that the operational possibilities given give above can be used in virtually any combination.

**To 1. Operation using the function keys T1 to T3 (63, 64, 65), together with information given in the lowest line of the graphic display (60).**

Pay attention to the information displayed above the function keys T1 to T3 (63, 64, 65). Activating the notice takes place by pressing the associated key.

**To 2. Operation using the rotary selector (61) together with information displayed via the graphic display (60).**

By pressing the rotary selector / key (61) one enters the main menu. Choose the function required by turning the rotary selector / key (61). Confirm the input by pressing the rotary selector / key (61).



Please note that the procedure presently being chosen can be broken off by using the ESC-key (62), and one then returns to the display which was selected under Display functions from the main menu.

## CC Operation using the rotary knob

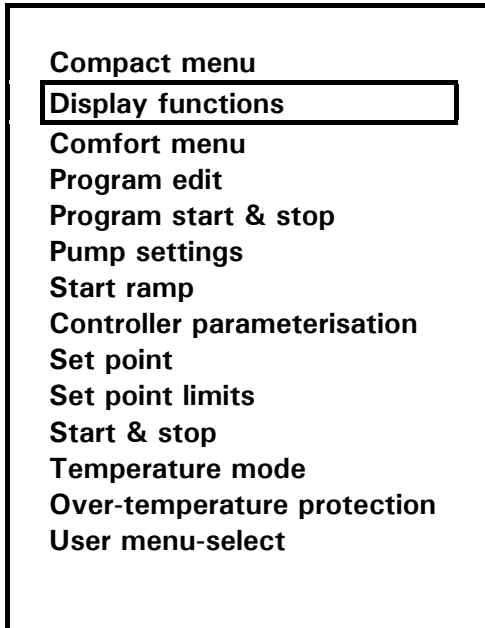

Once the rotary knob / key (61) has been pressed, the compact menu appears on the display screen. This menu lists the most commonly used options in alphabetical order. Turn the rotary knob / key (61) to highlight the required function and then press the knob to activate that function. An overview of these menu options is given in the **Main menu** chapter. Depending on the E-grade level, an upgrade can be made at any time with lower and middle levels, and the appropriate menu points will be displayed in the Graphic display (60). Please contact us at +49(0)781-9603100 or per e-mail under [info@huber-online.com](mailto:info@huber-online.com) concerning information regarding upgrades.

## CC Operation using the simulated Number Pad

Function number menu

Function number

F 0 Set point

^ v

1	2	3
4	5	6
7	8	9
ESC	0	OK

Keyboard

Set point

New value

Maximum value 50.00

Minimum value -20.00

1	2	3
4	5	6
7	8	9
.	0	-
ESC	OK	<-

### Function number menu:

Pressing the Funct.No. area at the bottom of the graphic display (60) will bring up the Number pad display. By using the rotary knob /key (61) you may enter the corresponding number fields, arrow fields, the **ESC-Field** and the **Ok Field**. Please note that the required function number can also be selected by rotating and then pressing the rotary knob / key (61). Once a valid function number is entered, the function number and description will appear in the graphic display. The **UP / DOWN** arrow keys can be used to step through the function list. Press the **OK button** to accept the function, and close the number pad. The functions are going to be displayed in the graphics display (60) Further description on individual functions are to be found in chapter **Function numbers and their meanings**.

### Keyboard:

By activating the **KEYB Function** you may also enter values. This function will be offered when entering the set point / set point limits. Please note that the required function number can also be selected by rotating and then pressing the rotary knob / key (61). The selected field will then be highlighted.

## Main menu

Following functions are available:

### Compact menu:

- Control mode
- Control parameters
- Display modes
- Main menu
- Overtemperature prot.
- Program edit
- Program start & stop
- Pump settings
- Setpoint
- Setpoint limits
- Start & stop
- Start ramp
- User menu – select
- Exit

### Comfort menu:

- Acoustic alarm
- AutoStart
- Clock
- Compact menu
- ComG@te
- Compressor automatic
- Control mode
- Control parameters
- Display functions
- Display modes
- E-grade Packages
- Factory default
- Language
- Limits
- Overtemperature prot.
- Program edit
- Program start & stop
- Protection functions
- Pump settings
- Sensor adjustment
- Service
- Setpoint
- Setpoint limits
- Settings (others)
- Software version
- Start & stop
- Start ramp
- Temperature scale
- Time scale
- 2<sup>nd</sup> setpoint

You will reach the main menu by pressing the rotary knob / key (61). Select the function to be used by turning the rotary knob / key (61) and activate it by pressing the rotary knob / key (61).

The individual functions are described in the following pages.

# Compact Menu

The functions used frequently are clearly listed in the compact menu.

## Display modes

Following functions are available:

1. Normal: Values are displayed numerically (valid for all temperature control devices with Unistat Pilot and CC-Pilot).
2. Graphic: Internal temperature, process temperature and set point are displayed graphically – valid for Unistat Pilot. (with CC-Pilot only possible with exclusive or Professional upgrade packet).
3. Display machine info: please see following example (valid for all temperature control devices with Unistat Pilot and CC-Pilot).
4. ComG@te Status: Information on switch condition of e.g. ECS and PoKo / ALARM (valid for all temperature control devices with Unistat Pilot and CC-Pilot).
5. Large display: Values are displayed in large numerical format (valid for all temperature control devices with Unistat Pilot and CC-Pilot).
6. Overview 1: Service information (valid for all temperature control devices with Unistat Pilot and CC-Pilot).
7. Back

**Display modes** is used to select the required display or information window (e.g. ComG@te status or display machine info). The standard setting is **graphic**.

Example: Display on choosing **Display machine info**.

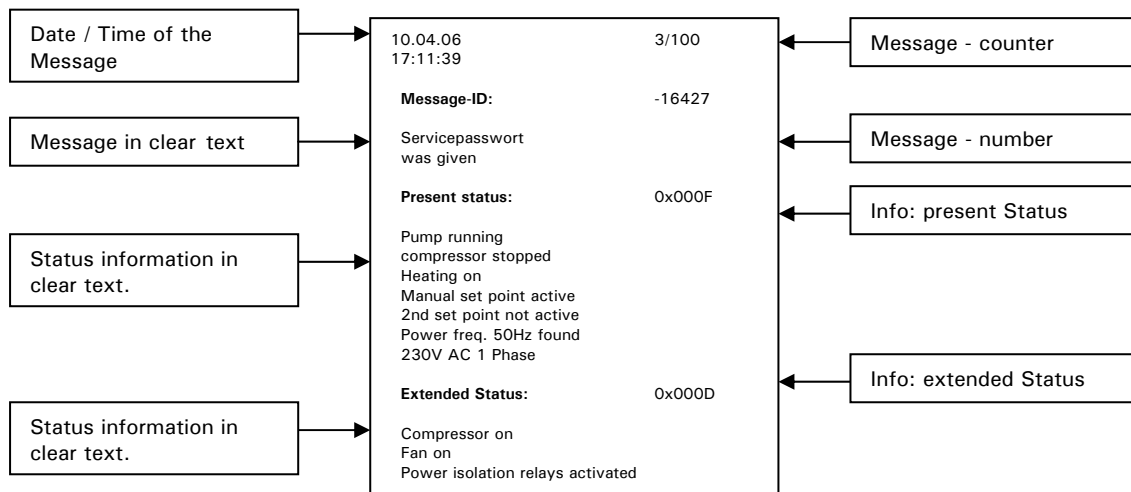

By turning the rotary knob / key (61) one can display the individual messages. Take note of the message counter for reference.

Example: Indication when choosing **Large display**

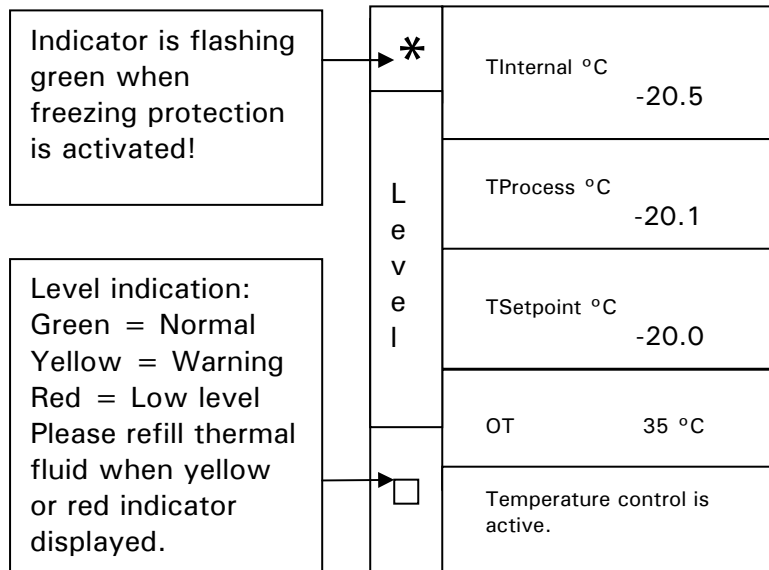

Please note: The indication freezing protection only applies to temperature control devices (generally Unichillers) with the freezing protection option!

**Comfort menu**

Here one can switch to the whole range of functions.

Please also note the chapter on **Comfort menu**, where further functions of the comfort menu are described.

**Program edit**

This corresponds to Function F20 in the Funct.-no. menu.

Here it is possible to write new programs, or programs already written can be edited and changed or erased. (**add segments, insert segments, erase segments or edit segments**) or erase whole programs.

Also one can set a particular behaviour at the end of the program through **Stop temp. control, continue** (temperature is continued at the last set-point) or **Repeat** (the Temperature program is restarted). One can also display the program elements as text or graphic. Working with the program creator will be described below.

**Start ramp**

Corresponds to Function F19 in the Funct. No. menu.

This ramps the temperature set point up or down as required, instead of a sudden temperature jump. It can be used in both internal and process control modes, to ramp the temperature at the internal or external temperature sensor (see function F3).

Note: A ramp can be started only if temperature control has previously been activated.

# Program creator

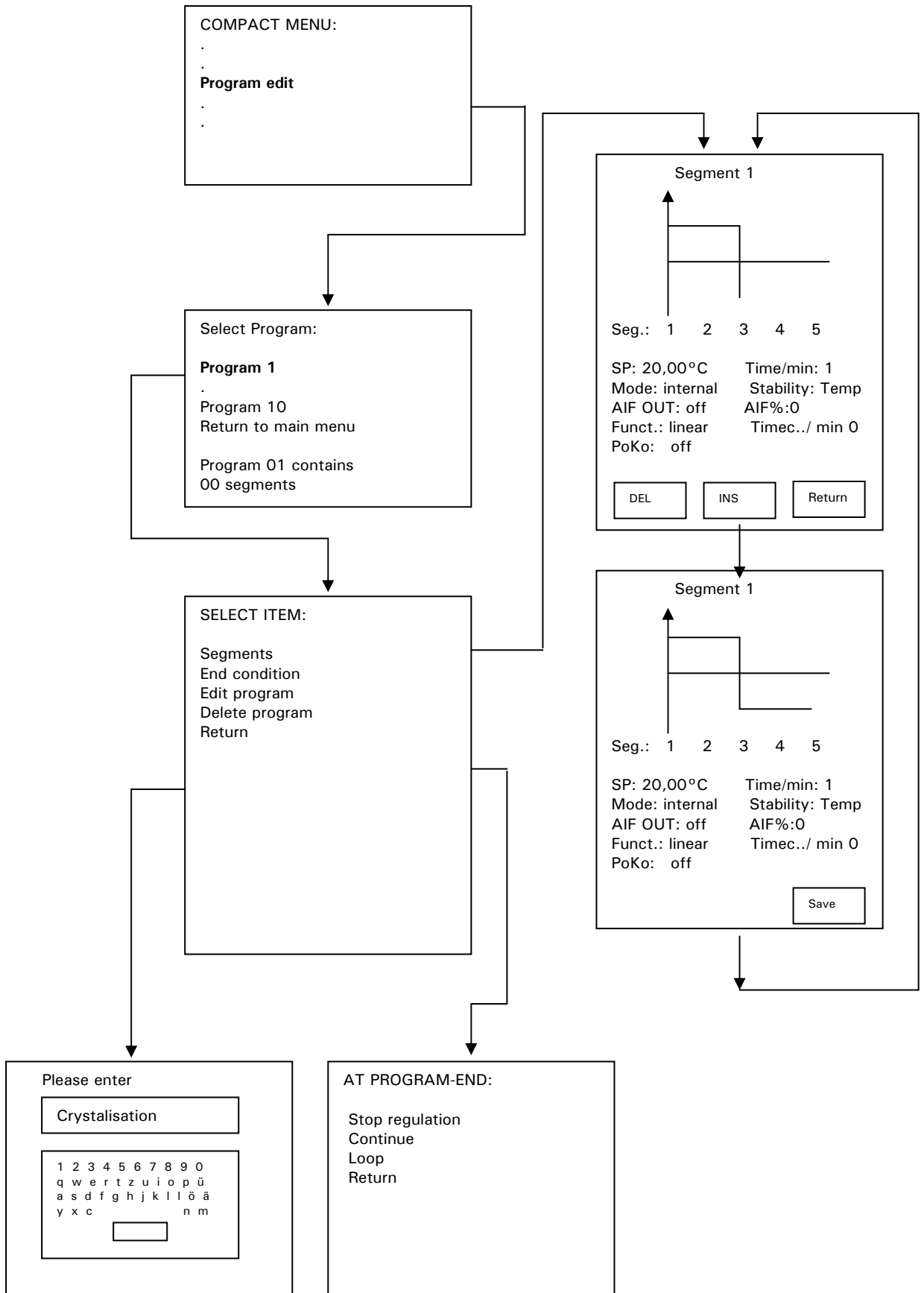



To create a new program, continue as follows:

1. Select the menu point **Program edit** from the Compact / Comfort menu.
2. Select the program number to be used. Information on the number of segments from the program currently used etc is shown in the lower part of the graphic display screen (60).
3. After selecting the program, more functions are displayed. Begin by selecting the **segment** option from the sub menu point. Confirm by pressing the rotary knob / key (61). The cursor (frame) points first to the set-point. Choose and modify each individual function (segment time, temperature mode,...) by turning the rotary knob / key (61). Press the rotary knob / key (61) to confirm your selection. By means of the function (soft-key) "DEL", "INS" and "RETURN" segments may be inserted easily and deleted. After having pressed the key "INS" select a segment no. by turning the rotary knob / key (61). This segment no. can be added as a new segment. Values can be modified by turning the rotary knob / key (61). Please note, that when selecting an exponential ramp function (E-grade Professional) the end value (more precisely 99% of the end value) will be reached after 5 times the time constant has elapsed. After having made all inputs confirm by pressing the rotary knob / key (61) and save the segment.
4. Via the sub menu point **End condition**, available options for the end of the program (e.g. **Stop temperature control**, or **Continue temperature control**) can be chosen.
5. A new program name can be entered from the menu point **Input program name** by means of the keys from the touch screen (60).
6. To delete a program, use the **Delete program** option from the sub menu and confirm the program to be deleted.
7. After entering a program, the **Program start & stop** option from the main menu can be used to call up, run and stop it. An early stop to the program can also be achieved by selecting the main menu point **Program start & stop**.



## Control parameters

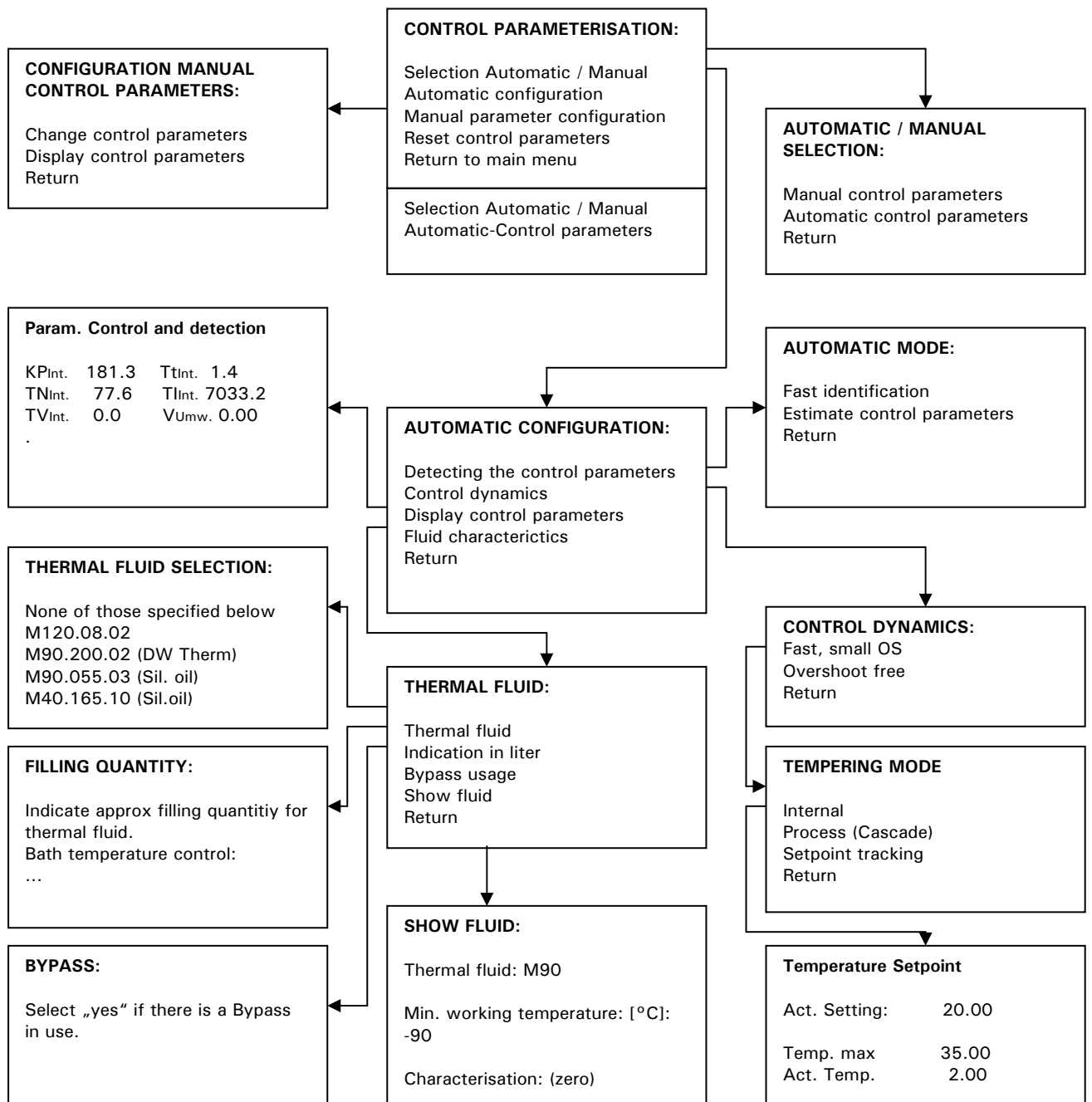

After selecting the main menu point **Control parameterisation**, the following functions are available:

- Automatic selection / Manual
- Automatic Config.
- Config. manual parameters
- Reset control parameters
- Return

### **Selection Autom. / Manual (Selection Automatic / Manual)**

Application of the automatically detected or manually entered parameters, in order to regulate the temperature. We recommend the setting: Automatic control parameters!

### **Config. Automatic (Automatic configuration)**

The following functions are available:

- Detecting the control parameters
- Control dynamics
- Display control parameters
- Fluid characteristics
- Return

#### **Detecting the controller parameters**



Two options of controller parameterisation are available:

- 1. Fast identification (not available with CC-Basic software)**
- 2. Estimate control parameters**

#### **To 1. Fast identification:**

Delivers a relatively fast and reliable control parameter with which a rapid regulation with a relatively high constancy can be reached.

First, start temperature control and run for some minutes to achieve a suitable stable set point. During the following do not carry out any changes on the system (e.g. filling / emptying the reactor core, change of agitator speed, change of the process sensor position etc.).

After activating this function, a table with thermal fluids is displayed. Select the appropriate thermal fluid here. If your thermal fluid is not listed in the table, please select **none of the specified**. If your thermal fluid is not listed, the controller assumes a thermal fluid with characteristics, which normally results in an overshoot-free (slower) control. After selecting the thermal fluid, you are asked, whether you want to identify and control **Internal** or **Process (cascade or set point tracking)**. You are then requested to enter a set point. Please note, that the identification is only successful, if the new set point differs from the current set point by at least 10 K. In the status field of the chart display (60), the information **Temp. + Ident.** active is displayed.

## To 2. Estimate Control parameters

In comparison to other temperature control devices on the market which have a fixed control parameter set, we do however offer an additional feature: an estimated control parameter, which by selecting the thermal fluid and quantity, then using one of the parameter sets estimated for your application.

### Control dynamics

After the control parameters are detected, control dynamics may be changed (see example below) without making new identification.

You can select between faster regulation behaviour with a small overshoot (submenu point **fast, small OS**) and a slower regulation behaviour without overshoot (submenu point **overshoot-free**). The default setting is overshoot-free. The statement overshoot-free only applies where any interfering action is small.

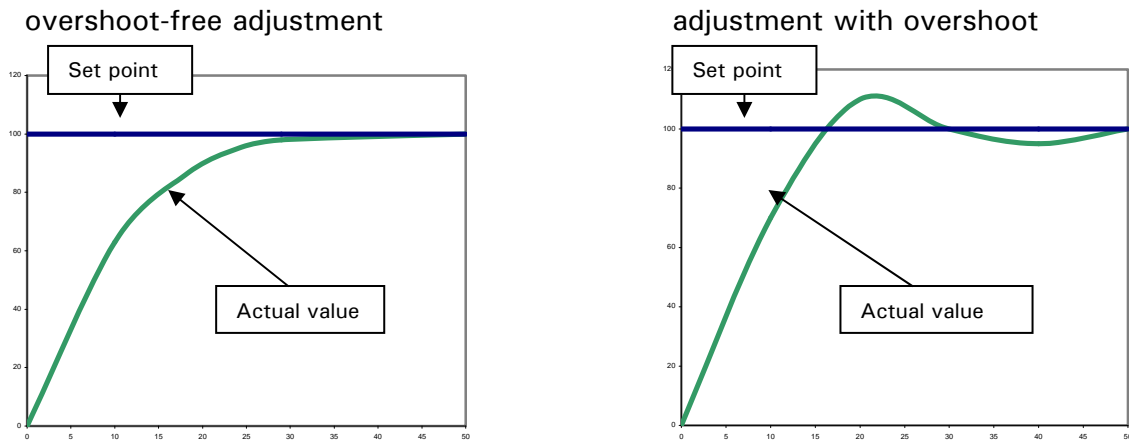

The illustration above shows the transient response for change of set point.



Note, that you can change the regulation behaviour at any time without having to make a new controller parameter detection.

### Display control parameters

You can have the automatically determined control parameters displayed here.

### **Set point**

This corresponds to Function F0 in the Funct. no. menu.

The set point is limited to the band between the upper and lower set point limits.

The following is true:

minimum set point  $\leq$  set point  $\leq$  maximum set point

### **Set point limits**

This corresponds to Function F1 and F2 in the Funct. no. menu. It allows the operating set point range to be set between user-determined minimum and maximum temperatures.

### **Start & stop**

Operating modes (temperature control, air-purge, circulation...) can be selected and activated / deactivated.

### **Control mode**

Following options are available:

1. Internal, corresponds to outlet temperature, jacket temperature control
2. Process (cascade, corresponds to e.g. external reactor temperature control)
3. Set-point following (the sensor value is used as set-point)

### **Over-temperature protection**

Cut-off limits can be set in the heating chamber / heating. Please note chapter on setting the **Overtemperature protection (OT)**.

### **User menu - select**

Under this point, one can choose which user menu (previously configured via User menu-config under the main menu point) should be used. Only this menu, with its approved points then will be seen.

## Comfort menu

### Display functions

Following functions are available:

1. The brightness of over-temp. and temperature seven-segment displays can be adjusted here.
2. Warnings (acknowledge manually or automatically)
3. Messages (acknowledge manually or automatically)
4. Inactivated menu points (display / blind out inactivated menu points)
5. Temperature resolution (0.01 °C, 0.1 °C)
6. Brightness. TFT Backlight.
7. Go back

### Display modes

A description on this menu point can be found in the chapter **Compact menu**.

### Acoustic

Here you have the option to activate / deactivate the acoustic signal output.

### AutoStart Behaviour (after power on)

This corresponds to Function F5 in the Funct.-no. menu. This allows the start-up condition, after mains failure to be defined.

The following is true:

AutoStart function = **OFF** / Standby

Temperature control will **not** be restarted when power restored (Default setting)

AutoStart function = **ON** / Temp. control active

Temperature control will be restarted on power-up.



### **Caution!**

The end-user should assess the risk and consequences of this setting for their application. The default setting is **OFF**.

### Limits

The following functions are available:

1. delta T limit (limitation of the jacket temperature to the reactor temperature)
2. Maximum heating value (limitation of the heating capacity in % steps)
3. Maximum cooling value (limitation of the cooling capacity in % steps)
4. Go back

You can here set the maximum allowable difference (**delta T limits**) between the internal temperature (jacket temperature) and the process temperature when using process control. If the chosen temperature difference is reached, then the temperature control device power is reduced so that this temperature difference is held. This function can protect the application (e.g. glass reactor) against thermal stress caused by too high a delta T.

### Settings (others)

Here, information concerning your application may be entered or read out. The values input here will be considered when controller parameterisation is taking place (please see chapter on **Control parameters**)

The following functions are available under the menu point **Changing thermalfluid**:

1. Thermal fluid (choose thermal fluid)
2. Indication in liter (indication on volume to be temperature controlled)
3. Bypass usage
4. Show fluid (values and information on thermal fluid are being displayed)
5. Back

Under the menu point **choose bath** different bath volumes can be chosen. Please select accordingly.

### Sensor Adjustments



There exists a possibility to carry out an adjustment of the internal sensor, the process sensor and the return sensor. We recommend to consult our service department before carrying out any adjustments of the internal sensor and return sensor. An adjustment is only necessary, if due to ageing of sensors measuring is inaccurate or insufficient. There are different reasons for inaccuracy of the process sensor, e.g. non-linearity, contact resistance. The new generation thermoregulation units give you the opportunity to carry out different adjustments. If the inaccuracy applies over the whole temperature range, adjustment should be carried out only at one point (offset adjustment). If accuracy is not constant over whole temperature range we recommend an adjustment of up to 5 spots. The more spots are included the better are the measuring results afterwards.

For adjustments you will need a reference thermometer with corresponding accuracy. The sensor of the thermometer has to be positioned as close as possible to the process sensor.

#### **Settings for the process sensor**

Start thermo control and enter a set point, which serves as first adjustment point. After set point is reached, wait until the temperature is constant. Choose the menu point **sensor adjustment / adjustment process sensor / new adjustment point** from the comfort menu. Enter the temperature measured by the process sensor into the first input field. This value has to be acknowledged via the OK-key. Enter the actual temperature measured via reference thermometer into the second input field. Confirm this value as well. Sensor adjustment at this temperature point is then completed. Optionally you can then fix a new set point used for second adjustment point. After set point is reached you may continue as described above (adjustment at the first adjustment point). To define additional adjustment points, continue in a similar manner.

### Compact menu

Here one can switch to the limited possibilities of the compact menu.

### Compressor Automatic

Corresponds to Function F35 in the Funct. No. menu. This is used to select the operating mode of the compressor. The default setting is **always on**.

#### **Automatic:**

The compressor control is set to switch on and off as required by the unit.

Benefit: Energy saving

Disadvantage: Longer response times to sudden increase in cooling demand.

#### **Always on:**

The compressor is always running, so the refrigeration system is always immediately available.

#### **Always off:**

The compressor is always off.



Compressor Automatic has to be switched to **always on** when setting **process safety** in the main menu point **over-temperature protection / reaction OT** (only valid for units with compressors).

### Program edit

This corresponds to Function F20 in the Funct.-no. menu.

Here it is possible to write new programs, or programs already written can be edited and changed or erased. (**add segments, insert segments, erase segments or edit segments**) or erase whole programs

Also one can set a particular behaviour at the end of the program through **Stop temp. control, continue** (Temperature is continued at the last set point) or **Repeat** (The Temperature program is restarted). One can also display the program elements as text or graphic.

### Program start & stop

Corresponds to Function F22 (temperature control program, altering run during operation) in the Funct.-no. menu. This enables the temperature control program to be paused at the current set point and to continue the program by pressing "Further", to leave the current segment and proceeding to the next one and to leave the program by pressing stop.

### Pump settings

Settings of speed (valid for VPC-Models) and pressure (valid for Petite Fleur).

### Start ramp

A description on this point can be found in the chapter on **Compact menu**.

### **Control parameters**

A description on this point can be found in the chapter on **Compact menu**.

### **Protection functions**

Following functions are available:

1. Upper alarm limit internal sensor
2. Lower alarm limit internal sensor
3. Upper alarm limit process sensor
4. Lower alarm limit process sensor
5. Warning time level (not valid for immersion thermostat CC-E and combinations using the immersion thermostat CC-E)
6. Go back

#### **Upper alarm limit - int: (Upper alarm limit - internal sensor)**

Corresponds to the Function F108 in the Function-no. menu.

The temperature monitoring is first activated when the internal (or process) temperature is below the maximum temperature limit. The temperature must "dip" into the limit band by 3 K, before an alarm will be generated. If the temperature limits are below room temperature, the unit temperature must first reach the temperature band before the monitoring is activated. This method allows the monitoring temperature to be easily checked and changed. An alarm is displayed if the temperature value set here is exceeded for more than 3 seconds.

**NOTE:** The default setting is set to a value that lies few degrees above the upper temperature limit of the machine.

#### **Lower alarm limit – int.: (Lower alarm limit - internal sensor)**

Corresponds to the Function F109 in the Function-no. menu.

An alarm is given when the measured temperature is lower than the set limit values for more than 3 seconds.

**NOTE:** The default setting is set to a value that lies few degrees below the lower temperature limit of the machine.

#### **Upper alarm limit Proc.: (Upper alarm limit - process sensor)**

Corresponds to the Function nr. F106 in the function menu.

An alarm is displayed if the temperature value set here is exceeded for more than 3 seconds. **NOTE:** The default setting is set to a value that lies few degrees above the upper temperature limit of the machine.

#### **Lower alarm limit Proc.: (Lower alarm limit - process sensor)**

Corresponds to the Function nr. F107 in the function menu.

An alarm is given when the measured temperature is lower than the set limit values for more than 3 seconds.

**NOTE:** The default setting is set to a value that lies few degrees below the lower temperature limit of the machine.



### **Low-level protection**

As low-level protection you can enter a warning time until the actual switching off of the temperature control unit. In case of low-level, a signal will be sent out (you therefore have to set the signal to **ON** in the main menu point **Acoustic**). Level indication will be displayed in red. A switch off, however, will take place after the warning time has elapsed. This function allows you to refill thermal fluid before it comes to a switch off due to low fluid level.

### **Service**

This menu is only available in service mode, and may only be accessed after contacting Huber. It allows the unit's internal sensors and other data to be directly read, for service purposes.

### **Software version**

Corresponds to Function F98 in the Function-no. menu.  
The installed software version of the electronics are displayed.

```
petite fleur
-25.0...150°C
Serial number: 77507
LoadCode: 803261629

Pilot: V06.00.021
May 8 2008 16:38:15
Serial number.: 80000

ActiveBrd: V06.00.001
Apr 9 2008 12:27:22
Serial number.: 99998

Further: Pressing the Encoder
key
```

### **Set point**

A description on this menu point can be found in the chapter on the **Compact menu**.

### **Set point limits**

A description on this menu point can be found in the chapter on **Compact menu**.

### **Language**

This corresponds to Function F90 in the Funct. No. menu, and allows the unit's operating language to be selected. The language options displayed are available.

### **Start & stop**

A description on this menu point can be found in the chapter on **Compact menu**.

### **Temperature scale**

It is possible to choose between °C, °F and K

### **Control mode**

A description on this menu point can be found in the chapter on **Compact menu**.

### **Over-temperature protection**

A description on this menu point can be found in the chapter on **Compact menu**.

## Clock

Sets the unit Time and date. A number of functions can be chosen, e.g. a calendar / reminder function and timed start can also be configured.

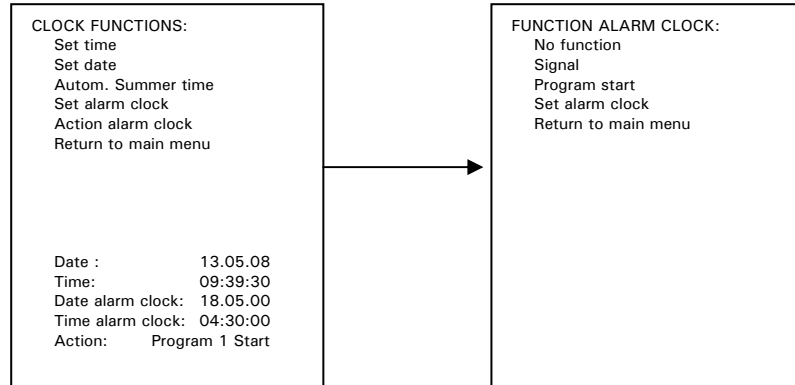

### Example: **Setting the alarm clock**

First enter the temperature programme via the main menu point **clock / action alarm clock / signal**. The signal will be given out when the time (date) is set via the function **clock / action alarm clock / set alarm clock**.

### User menu - select

A description on this menu point can be found in the chapter on **Compact menu**.

### User menu - config.

A description on this menu point can be found in the chapter on **Compact menu**.

### **Factory default**

This section allows the different areas of the temperature control unit to be reset to the factory default. This can be a relatively quick way of changing the unit settings.

### **Unit control data:**

Resets the set points, set point limits, temperature control mode, to the factory-set default values. Settings in the user menu and programs created using the programmer remain unchanged.

### **User menus:**

Resets the complete user menus to their default settings. Settings in the unit data and programs created using the programmer remain unchanged.

### **Programmer:**

Resets complete programs to default settings. Settings in the unit data and user menus remain unchanged.

### **All together:**

Resets the unit data, user menu, program, and controller parameters to default values.

### **Time scale**

The time display can be displayed in various formats (hh, min, sec).

### **2<sup>nd</sup> set point**

Corresponds to the Function F4 in the Function-no. menu.

The input of a 2<sup>nd</sup> or alternative set point is done in the same way as the normal set point under the menu point **set point**. This second set point is activated with an external control signal (Function F28) or through a watchdog event

# ComG@te menu

Here, the functions (**analogue-interface, ECS-Standby, PoKo Alarm and digital interface**) used in connection with an external control (e.g process control system "PCS") are listed.

## Analogue Interface

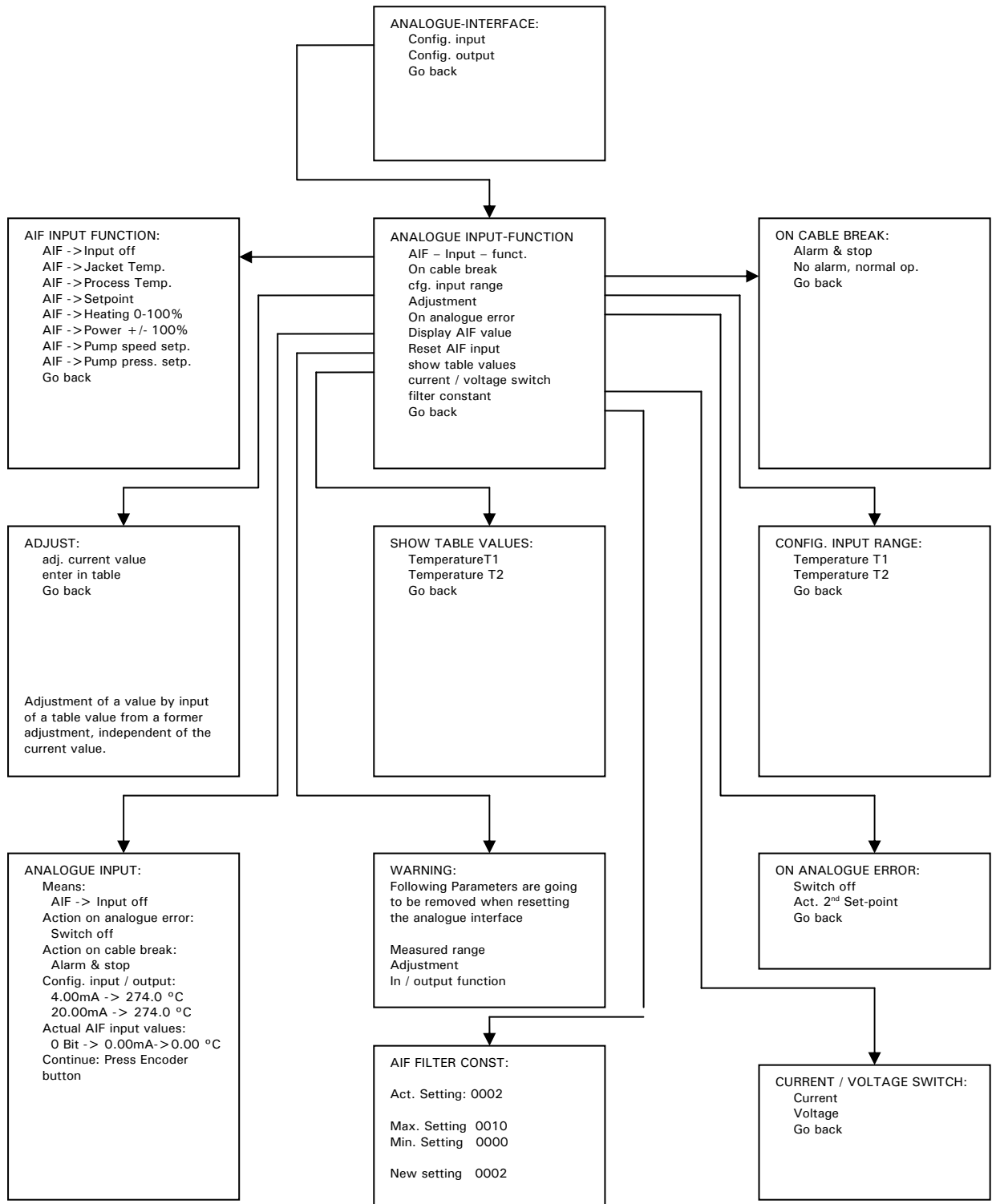

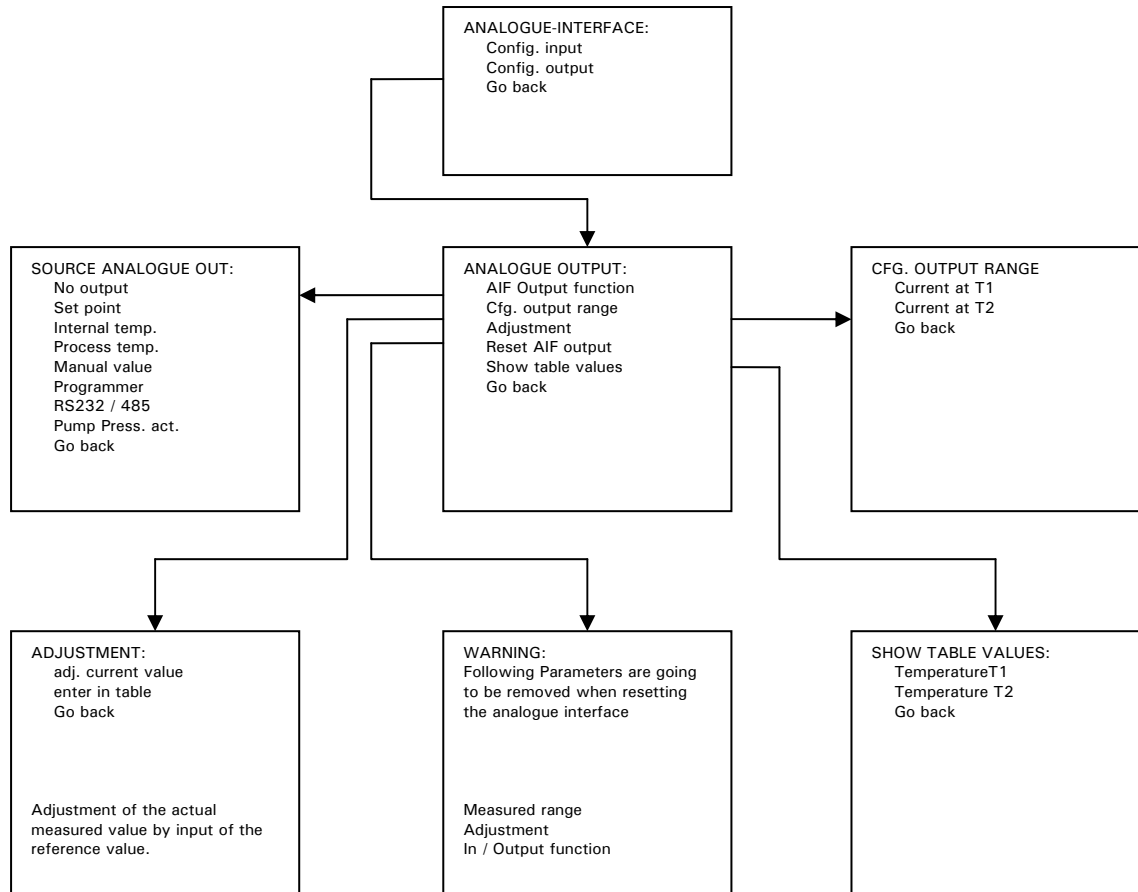

Using the **analogue interface**, the unit can be controlled via an analogue (0/4-20 mA or 0-10V) signal. An analogue (0/4-20 mA or 0-10V) output signal is also available. The schematic above describes the structure of the analogue input and output. Via the filter constant in the menu point **analogue Input** it is possible to smooth a noisy input signal. Below is an example using the analogue input to provide a set point, and the analogue output gives the process temperature. The current / temperature configuration is also shown.

E.g. Required operating temperature range is 0 °C to 100 °C. 0 °C should correspond to 4mA. 100 °C to 20 mA. The 4...20 mA (I / O) is available on the analogue interface connector. An alarm should be given when the cable breaks. The unit should be switched off if there is an analogue error.

## Settings:

1. Settings on temperature / current range  
Select **analogue interface / config. input / conf. transmitter**  
Enter the temperature range to correspond to 0/4-20mA (**T1=0 °C, T2=100 °C**).
2. Select input signal  
Select the input signal (**AIF-> Set point**) via **analogue interface / config. input / means AIF-input**
3. Select output signal  
Select the output signal (**Process temp.**) via **analogue interface / config. output / output value**
4. Select action if cable breaks  
Select **analogue interface / config. input / on cable break**  
**Trigger an alarm.**
5. Select action upon analogue error  
Select **analogue interface / config. input / on error analogue**  
**Switch off.**
6. The settings can be reviewed by selecting:  
**analogue interface / config. input / display AIF values.**

Please note that the fine signal adjustment functions the same for the analogue output as it does for the input.

### Setting information for fine adjustment.

**General:** When the machine is delivered and after a Reset (Reset AIF input) the interface will be set accurately enough. An adjustment is not necessarily required.

It is possible at any time to adjust the precision of the input channel. This could be required if the set point input current does not coincide with the expected temperature value. If as shown in point 1 above, an input of 4.000 mA does not give exactly 0 °C, but maybe 1 °C. A fine adjustment then can then be made. Change to menu point **analogue-interface / config input / fine adjust / xxxxx**. Feed 4.000 mA into the interface. Confirm the value. Choose then **analogue-interface / config input / fine adjust / xxxxx**. Feed then 20.000 mA into the interface. Confirm the value. At the end, a current input of exactly 4.000 mA should give a set point of 0 °C and a current input of 20.000 mA should give a set point of 100 °C.

The fine adjustment of the output channel is done in a similar manner. A sensor value of 0 °C and 100 °C should give an output current value of 4.000 mA and 20.000 mA.

## **Digital Interface**

Following functions are available:

1. Hardware RS (option between RS232 and RS485)
2. Baudrate (selection of transmission speed)
3. Machine address (Selecting a bus address, only when using RS485)
4. Test dig. Interface (command TI is send via RS232)
5. Go back

## **ECS / Standby External control signal**

Corresponds to Function F28 in the Funct.-no. menu.

This is a potential free input. A closed contact switches e.g. temperature control on, and an open contact switches e.g. temperature control off.

Please also refer to the **ComG@te** section of this manual.

Following functions are available:

1. **No action**
2. **Switch to 2<sup>nd</sup> set-point**
3. **2<sup>nd</sup> set-point selective**
4. **Internal / Process**
5. **Temperature control ON / OFF**
6. **Release**

### **\* No action:**

A switch of the contacts open / closed or closed / open has no effect.

### **\* Switch to act. 2<sup>nd</sup> set point const.**

Switching the closed contact to open contact causes the unit to use the value of the second set point. A further switch from open to closed contact causes the unit to continue temperature control at the second set point.

### **\* 2<sup>nd</sup> set point selective**

An open contact causes the unit to use its internal set point. A closed contact causes the unit to use the value of the second set point.

### **\* Internal / Process**

A closed contact causes the unit to immediately switch e.g. between internal and external control mode. An open contact causes the unit to switch back to its original control mode.

### **\* ON / OFF temperature control**

Switching from open to closed contact causes the unit to start temperature control. Switching from closed to open contact causes the unit to stop temperature control.

### **\* Release**

Switching from closed to open contact while temperature control is operating causes the unit to stop temperature control. Switching back from open to closed contact **does not start** the unit.

### **PoKo alarm      Pot. free Contact (PoKo)**

Corresponds to Functions F6, F7, and F8. This function allows a relay contact, in the ComG@te (46) to be controlled and activated. Please also review the **ComG@te** section of the manual.



The following functions are available:

#### **Not used:**

The PoKo displays the OK status when the unit is ready to operate. This condition is after the internal controller check, approx. 30 sec. after the switch on. The OK status will be ended by switching off the mains or a fault.

#### **Check temp.:**

The relay switches when the current internal temperature is outside the range set between the PoKo minimum and maximum internal temperatures (F6 and F7). The values in functions F6 and F7 are relative to the current set point. If the range is exceeded the potential free contact is switched (from the OK status), and the unit will continue to operate. If the actual value is in the range, the contact will be reset to the OK status.

#### **External alarm:**

The PoKo relay is only activated if the unit is in "fault status" when it is switched on. This is so that the alarm is not raised when the unit gets switched off. If you wish the alarm function together with the work flow principle, please use the PoKo function **OFF**.

#### **Unipump / PCS: (Unipump / Process Control System)**

This PoKo function is used to connect the signal calling for the circulation pump to start with an external booster pump. This has to be done so that the external pump runs in synchronisation with the circulation pump in the unit, this means that the PoKo activates (to the OK status) as soon as the circulation pump starts.

PCS: An example of this would be when temperature control would be controlled by a "PCS" via the external control signal (Menu point External control signal or Function F28), the PoKo can be used to communicate.

Condition PoKo **ON** means temperature control is activated.

Condition PoKo **OFF** means temperature control is not activated.

#### **Controlled by RS232:**

The relay is controlled via an RS232 command. Therefore please note our Huber-Software.

#### **Check measured process temp.:**

A measured temperature check for the PROCESS SENSOR providing it is not the control sensor. The PoKo relay switches when the current external, (process temperature) is outside the range set between the PoKo minimum and maximum external temperatures. When the unit is set to internal control, and the PoKo check process temperature" is selected, the temperature of the external sensor is monitored – this sensor can be independent of the internal temperature and the temperature control process. The limits set by F6 and F7 still apply.



**Unipump with echo:**

This function is used to monitor if the Unipump being controlled by the PoKo is operating in synchronisation with the Unistat's own pump. The operating status of the Unipump can be signalled via a closing-contact by connecting to a "level" connector. If the Unipump does not operate with the machine, a fault signal will be generated. This operating mode is very useful if the Unipump has to be monitored, either to guarantee the desired temperature control or to avoid unintended heating of the thermal fluid.

**Programmer:**

The relay is controlled by a command from a segment within a temperature profile running on the programmer. Please also note the menu point on **Program edit**.

**Check Internal temp. absolute (check internal temp. absolute)**

The relay switches when the current internal temperature is outside the specific band determined by the maximum and minimum temperature limits. Outside this band PoKo is active, within the band PoKo is inactive.

**Check Process temp absolute. (check process temperature absolute)**

The relay switches when the current external temperature is outside the specific band determined by the maximum and minimum temperatures. Outside this band PoKo is active, within the band PoKo is inactive.

## Function Numbers and their meaning



A detailed description of the functions, as well as an alternate operation for the menu guide can be found in the chapter **Compact-/ Comfort-/ ComG@te menu**

### **F0 Set point**

minimum set point  $\leq$  set point  $\leq$  maximum set point

If an attempt is made to enter a set point outside these limits, then a warning message will be shown on the display (60) and the set point will not be accepted.

### **F1 Minimum set point, F2 Maximum set point**

The range for the set point limits should conform to the safety data sheet of the thermal fluid being used and the working temperature range allowed by the administrator.

### **F3 Control mode**

Internal temperature control or Process temperature control.

### **F4 2<sup>nd</sup> set point**

Alternate set point which is being entered after activation.

Please also note the setting of function F28 (External control signal).

### **F5 Auto Start**

Auto Start = **ON** / Temp. control active.

After power loss – Temperature control will be restarted on return of power.

Auto Start = **OFF** / Standby

After power loss – Temperature control will not be started on return of power.



### **Caution!**

The end-user should assess the risk and consequences of this setting for their application. Default setting is **OFF**.

### **F6 PoKo maximum limit (Pot. free Contact Maximum temperature)**

Used in conjunction with function F8. This function sets the upper limit (delta T) relative to the set point.

### **F7 PoKo minimum limit (Pot. free Contact Minimum temperature)**

Used in conjunction with function F8. This function sets the lower limit (delta T) relative to the set point.

### **F8 PoKo - programming**

The options for the potential free contact are given and described in the earlier **Potential free Contact** section the **ComG@te** menu of this manual (**Pot. free Contact**).

### **F9 Controller parameterisation**

Please see chapter **Controller parameterisation in the Compact menu** for detailed description.

### **F10 Machine messages**

Information on the machine about condition (status, warnings and faults).

### **F12 Adj. internal sensor**

Up to 5 free selectable temperature values for the adjustment of the internal sensor can be defined and adjustment may be carried out. Please also see description on **sensor adjustment** in the chapter **Comfort menu**.

### **F13 Adj. process. sensor**

Up to 5 free selectable temperature values for the adjustment of the process sensor can be defined and adjustment may be carried out. Please also see description on **sensor adjustment** in the chapter **Comfort menu**.

### **F14 Adj.return sensor**

Up to 5 free selectable temperature values for the adjustment of the return sensor can be defined and adjustment may be carried out. Please also see description on **sensor adjustment** in the chapter **Comfort menu**.

### **F18 delta-T limit**

Maximal admissible temperature difference between internal and process temperature. Once the maximum temperature difference has been reached, the unit will automatically reduce its cooling (or heating) capacity as required.

### **F19 Ramp function**

The set point default refers to, depending on the temperature mode set (function F3) the internal sensor or process sensor.

### **F20 Program edit**

You can edit the chosen temperature programme.

### **F22 Program control**

Choose between following options: **Start, Stop, Break, Skip to the end segment** of a running temperature programme.

### **F23 Program start**

Start of the temperature programme (calendar start).

### **F27 Time scale**

Time scale in minutes or hours.

### **F28 Ext. control signal (External control signal)**

The external control signal can be used to control one of a number of available unit functions. Please see chapter on **ComG@te** menu.

### **F30 Set date**

Setting the date.

### **F31 Set time**

Setting the time.

### **F33 Set over-temperature protection**

Setting the over-temperature protection. Please note chapter on setting the **over-temperature switch**.

### **F34 Air purge**

Start / Stop air purge

### **F35 Compressor control**

This is used to select the operation of the compressor: Default setting is **always ON**

#### **Automatic:**

The compressor control is set to switch on and off as required by the unit.

Benefit: Energy saving

Disadvantage: Longer response times to sudden increase in cooling demand.

#### **Always ON:**

The compressor is always running, so the refrigeration system is always immediately available.

#### **Always OFF:**

The compressor is always off.



The compressor automatic (valid for units with compressors only) must be set **always on** when selecting **process security** in the main menu **Over-temperature / Reaction OT**.

### **F37 Temperature mode**

Setting the temperature mode.

### **F39 Signal**

Activating the signal.

### **F40 Test RS232**

Start / Stop

### **F41 Select user menu**

Please refer to chapter **select user menu**.

### **F42 Configure user menu**

Please refer to chapter **configure user menu**.

### **F46 Define analogue input (function analogue input)**

This function allows an analogue input current of 0/4-20 mA or 0-10V to be assigned to an input value.

**F47 On cable break**

This function determines the unit’s response to a break in the cable, e.g. turn off temperature control, or control to a second set point.

**F49 Unit name**

This function displays the unit model number.

**F50 Input password**

Used only for Service. Contact Huber for further information.

**F52 Factory default**

This functions allows to reset the unit to the factory default.

**F55 Degassing mode**

Activating the degassing mode. Please see the section on **Degasing an external closed application**.

**F60 Information on the machine**

In this function information on the machine can be obtained.

**F61 X-Information (Service)**

XX

**F68 Tempmove AIF – Tint**

XX

**F69 Tempmove AIF Tproc**

XX

**F70 Service increments**

May only be used under directions of our Customer Support Team.

**F71 Service functions**

Used only for Service. Contact Huber for further information.

**F72 Service temperature**

Used only for Service. Contact Huber for further information.

**F75 Cooling power man.**

One can here set a constant cooling power. An automatic cooling power adjustment does not take place.

**F84 Slave address**

Setting the unit’s BUS-address.

**F85 Baudrate**

Setting the Baudrate.

**F86 Select RS232 / 485**

Choosing the interface.



**F130 Display mode graphic**

Choosing graphic display.

**F131 Display mode normal**

Choosing standard display mode.

**F135 Adj. analogue input (analogue interface input current adjustment)**

Fine adjustment of the 0/4-20 mA or 0-10V input current range. Using this function the current limits of the 0/4-20 mA or 0-10V analogue input signal can be calibrated.

See also the chapter on the **ComG@te**.

**F136 Adj. analogue outp. (analogue interface output current adjustment)**

Fine adjustments of the 0/4-20 mA or 0-10V output current range. Using this function the current of the unit's 0/4-20 mA or 0-10V analogue output signal can be calibrated, this is the current limits for your measured output or difference output via the AIF (see function F138).

**NOTE:** Also see the chapter **ComG@te**.

**F137 AIF input current / T**

Setting the current / temperature assignment for the A / D converter at the analogue input.

**F138 AIF output meaning**

Assignment of a temperature value to the output current.

**F180 Heat. power limit**

This function allows the available maximum heating capacity of the unit to be set between 0...100%.

**F181 Cool. power limit**

This function allows the available maximum cooling capacity of the unit to be set between 0...100%.

## Configure User menus

Using the configure menu function up to seven different operational modes can be set up. This is comparable to the main menu point **Compact menu**. However here the user menu can be stopped and edited at any time. There is also the ability for an administrator to create and save menu lists for individual users. Reducing the number of options in a list can give a clearer display and overview of the operation, as well increase security by locking out other functions.



Please note that the Configure user menu is password (code input) protected. For information on the enter code please contact our Customer Support Team.

The path to select a user menu is given below:

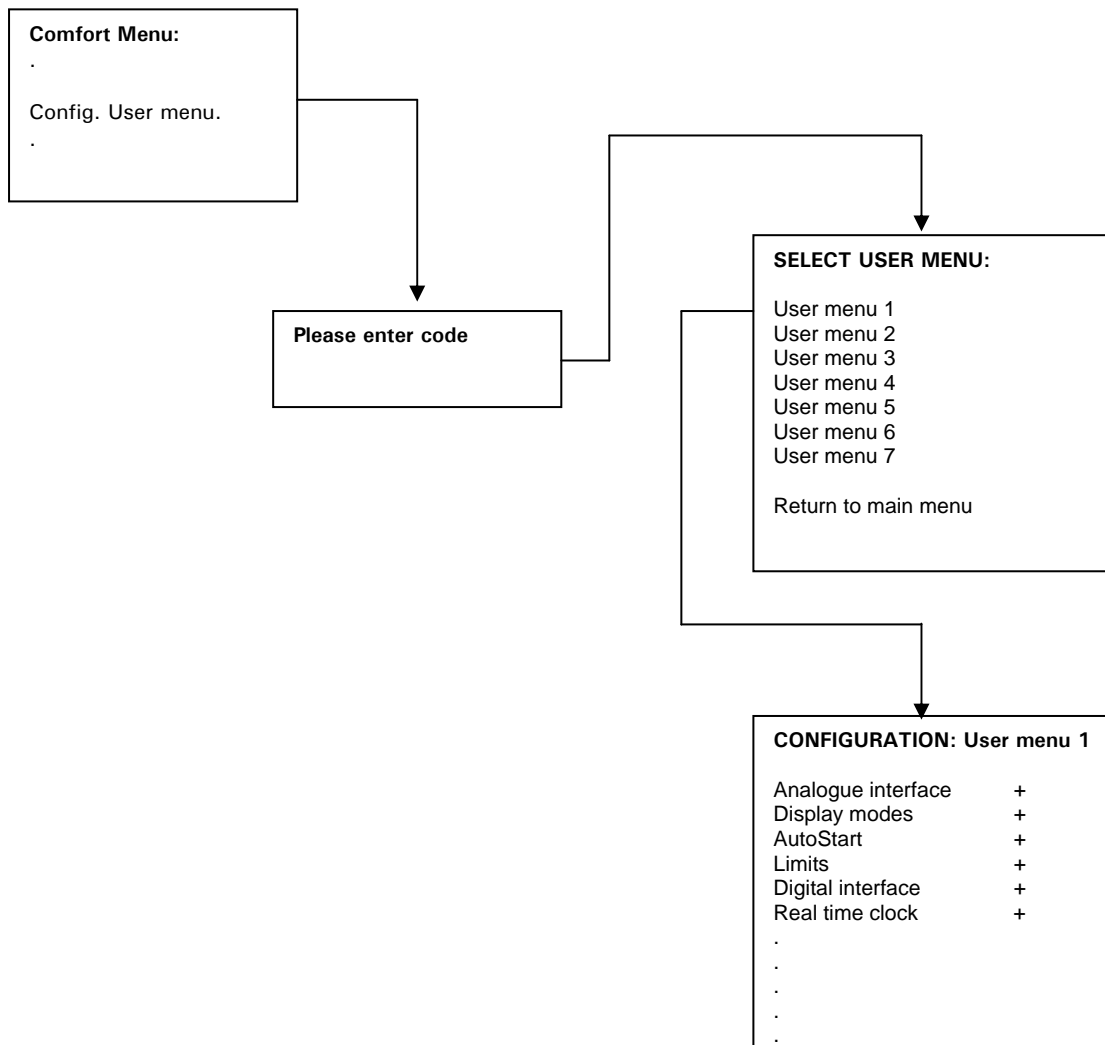



After entering the password, select one of the available user menus to enter the configuration program. After that you will enter the actual configuration program. A list of the comfort menu will be displayed. At the end of each of line there will be a "+" if that function is active. This can be changed to a "-" using the control button / knob (61) to deactivate it.

## Select User menu

This option can be used to configure a user menu to be operated like a new main menu. In this case only the main menu points are accessible that have been previously activated through the main menu point "configure user menu".



Please note that the User menu configuration is password protected.

The path to select a user menu is given below:

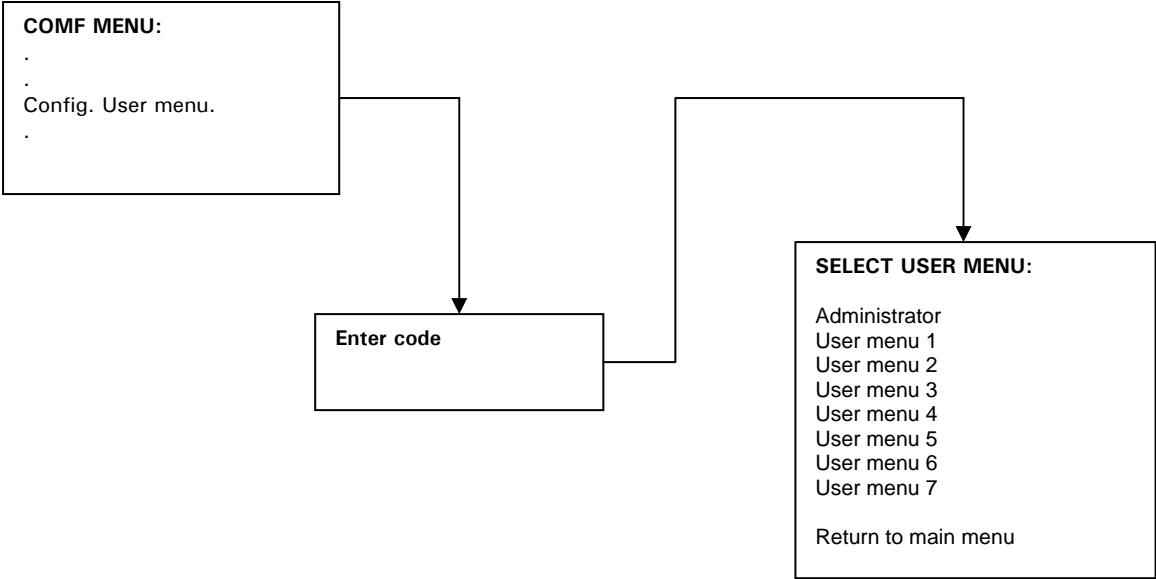

After entering the correct password (please contact our customer support team), one of the available user menus can be selected. To return to using the full function, **main menu**, select the Administrator option from the **user menu list**.

## **Chapter 3: Connect the machine, fill and prepare for the required application**

- Power connection
- Start up
- Connecting an externally closed application (reactor)
- Switching on the temperature control unit
- Setting the over-temperature (OT) switch
- Setting the level indicator with capacitive level identification (for chillers only)
- Setting set point limits
- Entering a set point
- Starting temperature control
- Ending temperature control
- Filling and air purging an externally closed system
- Draining the machine and an externally closed application
- Changing heat transfer fluid / internal cleaning

## Power connection



**Danger!**

Check to make sure that the line voltage matches the supply voltage specified on the identification plate or data sheet.

We disclaim all liability for damage caused by incorrect line voltages!

## Safety instructions



<b>Danger!</b>	Only connect the unit to a power socket with earthing contact (PE – protective earth)!
<b>Caution!</b>	Do not move the unit from its location while it is running.
<b>Danger!</b>	Never operate equipment with damaged mains power cables.

## Start up



General

All models must be moved and installed in an upright position. Provide for a stable installation and make sure that the thermostat cannot tilt. Ensure that sufficient fresh air is available for the circulation pump and compressors at the installation site. The warm exhaust air must be able to escape unhindered upwards.

## Freezing protection (only valid for temperature control units with the option freezing protection)

Temperature control devices (especially unichillers) with the option freezing protection are capable of using water as thermal fluid. An additional freezing protection may be activated for temperature control devices with the option freezing protection under the main menu point **Protection functions / Freezing protection** to avoid critical situations such as temperatures  $< 5^{\circ}\text{C}$  at the internal heat exchanger and the risk of freezing of the heat exchanger. A green flashing ice crystal indicates the activated freezing protection under the main menu **Display modes / Large display**.

## Water-cooling (valid for units with water cooling)



A cooling water controller is used in Huber tempering devices with water cooling, in order to reduce the cooling water consumption. This only allows as much cooling water to flow as is required by the current load situation of the tempering device. Only little cooling water is consumed, if the required refrigerating capacity is low. No cooling water flows in the OFF state. Only use pressure-resistant hoses in the cooling water circuit.

Connection diagram:

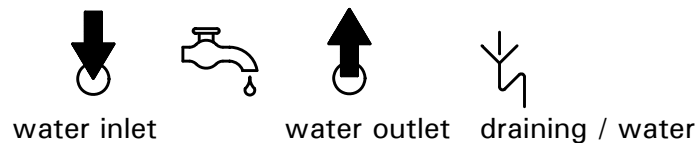

Caution!

Depending upon mode of operation and available cooling water pressure, a cooling water pressure of  $> 2$  bar can build up in the cooling water supply line. In order to avoid flooding of the premises, check the leak tightness and quality of the hoses, hose connections in regular intervals, and if necessary take appropriate measures (Replacement). Close down the cooling water supply to the tempering device even during shorter shutdowns (e.g. over night).

Reinforced hoses must be used for increased safety requirements.



Preparation of devices with water-cooling:

Establish the hose connections for the cooling water. The filter screen has to be inserted into the cooling water inlet. Please infer the position of the cooling water connections from the connection diagram in the appendix. Cooling water connectors Drainage with seal cap held closed and /or close. Open all stop valves. Please infer the minimum / maximum differential pressure in the cooling water circuit and the recommended cooling water inlet temperature from the data sheet.

Information on water quality can be found on our website ([www.huber-online.com](http://www.huber-online.com)) under "Download / Safety data sheets thermofluids / Characteristics of water".

## Connecting an externally closed application

Remove the thread covers from the Fluid outlet (1) and Return (2).

Make sure that the hose material is compatible with the thermal fluid and temperature range being used. In order that the application can be driven correctly, and that no air bubbles remain in the system, ensure that the unit fluid outlet (1) is attached to the lowest connection on the application, and the unit fluid return (2) is attached to the highest connection on the application.

Please note the markings for the hose connections on the housing

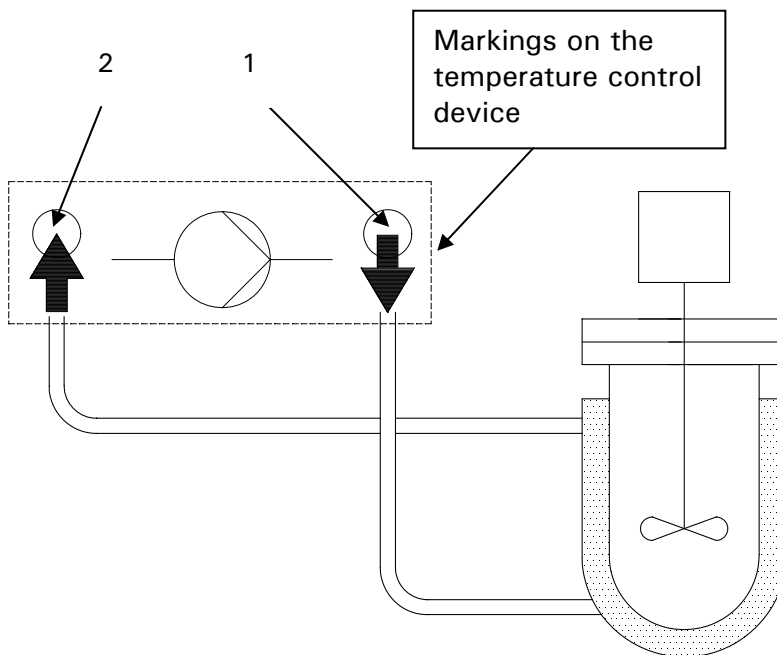

## Switching on the temperature control unit

Switch on the unit using the mains switch (36). The unit performs initialisation tests, to check the full functionality of the thermoregulation unit. The control electronics first check the heaters, the sensors and then relays. If an error, or warning condition, arises, a message will be shown on the graphic display (60) giving details of the problem. For further information and assistance please contact our Customer Support Team.

# Setting the over-temperature (OT) switch

(also valid for Chillers with heating)

## General Information

The over-temperature switch is an independent function of the CC-Pilot. The software and hardware is configured so that essential functions and operations are tested during the self-test when the unit is first powered on. If a problem arises then the unit is automatically prevented from operating until the problem is rectified. During these tests the sensors are tested for short- and open- circuits.

The constant monitoring of the internal temperature provides safety for the connected application. It should be set immediately after being filled with thermal fluid.



### Warning!

The over-temperature switch should be tested at least monthly, and after changing the thermal fluid.

The over-temperature switch should be set at least 25 K below the burning point of the thermal fluid.

Select the **Over-temperature switch** option from the main menu.

When received, the cut-off will be set to 35 °C. If the temperature of the thermal fluid is higher then this when filled the machine switches off and an alarm will be given after a short time. After removing the cause of the error e.g. by using a thermal fluid with a higher burn point and the correct setting of the **Over-temperature protection** from the **Comfort menu / Compact menu**, start the device again.

Over-temperature protection
OT set point
OT xxx
OT control
Display all
Return to main menu

After selecting an option then the display (60) will show the following message:  
**Code for over-temperature xx**

xx is a number between 0 and 65000 that changes for each entry. The number is displayed for about 3 seconds. Please note this number to continue.

To adjust the over-temperature switch, enter the number when requested. This procedure is to prevent the accidental adjustment of the over-temperature switch.

After selecting **Display all** the following information appears on the display (60):

OVER-TEMPERATURE PROTECTION	
Current value Hz.1	32.2 °C (Main heating)
Current value Hz2	34.0 °C (Fine heating)
Current value Exp.	30.3 °C
OT Setting Hz1	35.00 °C
OT Setting Hz2	35.00 °C
OT Setting Exp	35.00 °C
Reaction over-temperature	
Stop to DIN 12876	
Further: Pressing the rotary knob	

### Over-temperature alarm



Please note the over-temperature response function. There are two options available:

#### **Stop according to DIN EN 61010**

When the cut-off temperature is reached, heating, cooling and pump are all turned off (Default setting).

#### **Process security**

When the cut-off temperature is reached the heating is turned off, but the cooling and pump remain on. The full cooling capacity of the unit remains available for emergency cooling (possible exothermic reaction). Please ensure that the compressor automatic is switched to **always on** using the **Comfort menu** point compressor automatic (F35). Please see description on **Function numbers and their meanings**.

The function process security is not possible with ministats.

## Setting the level indicating meter with capacitive level identification

Besides the sight glass or level indication based on the principle of float switches there are also machines with a level sensor using a capacitive principle. With these units there is a coloured level bar which indicates the level in the graphic display (60).

For these units the main menu point **Protection Functions** is extended to: **Level Warning High** and **Level Warning Low**.

The LOW value can be entered within the range of 0 % to 100 %. The adjustable HIGH value takes into account the LOW value and may not contain a value lower than the LOW value.

A colour change of the level bar takes place only if the current value lies outside these limits. Please take precautionary measures by refilling thermal fluid when too low a level and respectively drain thermal fluid when level is too high. Please read the appropriate chapters in this manual.

When filling for the first time or if the accuracy of the indication is not satisfactory, then please use the menu point **Level Teaching**.

This may apply when e.g. not using anti-freeze for a chiller and not using thermal oil for a unistat. Teaching corresponds to an adjustment of the level sensor with a filling of 100%. Teaching must to be carried out only when using the right heat transfer medium and under ambient temperature conditions. The level is measured by the sensor within the sensor tube.

The level in the sensor tube corresponds to the level in the surrounded container because level is balanced through the level hole. To reach a 100% filling level, either fill the unit to the maximum or reset the level in the sensor tube. A stable filling of the sensor tube is not possible due to the level hole, therefore it has to be set in upside down. The same level hole is responsible for the 100% level.

Therefore open the filling connection. Manually unscrew the black screw cap of the sensor tube. Unscrew and loosen the sensor tube by means of the supplied special spanner. Remount it upside down and screw it back as before. Fill enough thermal fluid into the sensor tube only, that it leaks out of the hole (overflow).

**Important:** Mount the black screw cap back to ensure a correct capacitive adjustment. Note that, when activating the **teaching** in the main menu point, the level indication in the graphic display will rise up to 100%. The accuracy of the indication corresponds to a float switch level indication with 5 positions. Now return the sensor tube to its original position

### **For air cooled machines and designated outdoor versions:**

Dismantle the lid and the left upper casing. Unscrew the knurled screws and remove the lid as well as the left upper casing. Then start teaching as described above.



**Delivery status and normal**

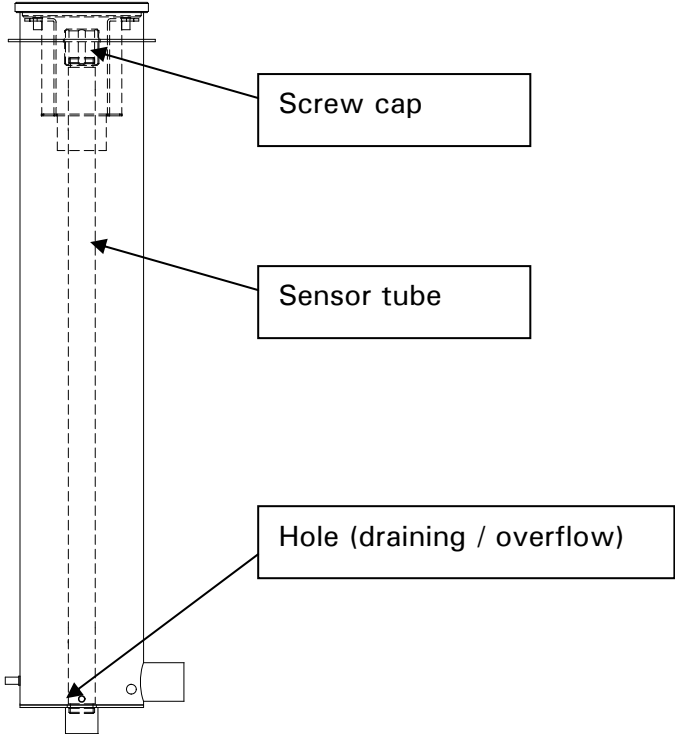

**Teaching operation**

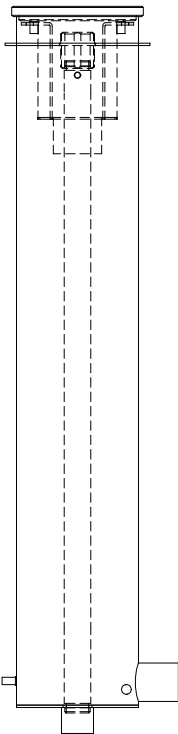

## Setting the set point limits

The minimum and maximum set point limits provide safety for the equipment. These limits should be set before starting temperature control, and checked if the heat transfer fluid is changed. The maximum set point limits the lowest temperature that can be input and reached, the minimum set point protects against the effects of too low a temperature such as high viscosity or freezing of the thermal fluid. The set point input is only possible in the band between maximum and minimum set point.

Select the **Set point limits** option from the **Main menu**. Enter the required minimum / maximum set point using the rotary knob /key (61), and then confirm it by pressing the rotary knob / key (61).

Check the value of the minimum and maximum set point for every system change, in particular if the thermal fluid is changed.

## Entering a set point

Select the **Set point** option from the **Main menu**. The new set point can be chosen, and confirmed using the rotary knob (61). The value of the set point is limited by the current minimum and maximum set-point limits.

The following is true:

minimum set point  $\leq$  set point  $\leq$  maximum set point

If an attempt is made to enter a set point outside these limits, then a warning message will be shown on the display (60) and the set point will not be accepted.

## Starting CC Temperature control

After filling and fully air purging, the temperature control can be started. Choose the menu point **start&stop** via the **Main menu**. Confirm and activate by pressing the rotary knob (61). Alternatively, one may press the function key T3 (65) to start the temperature control.

## Ending CC Temperature control

The temperature control can be ended at any time by pressing the function key T3 (65). The temperature control and circulation is immediately stopped. Alternatively, to set the unit to standby mode and use the main menu point **Start & Stop** - menu point **Stop temperature control**.

### For units with compressor:

The main switch (36) can be used to turn the power off only after the compressor has been stopped by the controller.



Room temperature should be reached before the temperature control is ended. Protect your application by **NOT** closing any isolation and drain valves. Overpressure / underpressure can be built up within the system if valves are closed and temperature adjustment takes place.

## Filling and air purging an externally closed system



### Caution!

- Fill to the unit to the minimum level necessary.
- Please refer to local regulations and internal procedures.
- When filling the unit, extra precautions such as earthing the expansion tank, fluid container funnel and application may be necessary.
- Personal Protection Equipment (PPE) should be worn as required by the fluid MSDS sheets, and local regulation.
- Please note the temperature of the thermal fluid. The fluid should be left a room temperature for a few minutes before draining.



### Warning!

Overflowing thermal fluid will create a film on surfaces, which should be cleaned up and properly disposed of as soon as possible in accordance with the MSDS information. If thermal fluid is spilled over the unit, the unit should be immediately turned off, and Huber-trained personnel consulted.

Failure to observe the above precautions may mean that the unit will not comply with all of the requirements of DIN EN 61010-2-010.



### Filling

- Lift the bath lid / cover from the bath / inlet nozzles
- Carefully pour a suitable thermal fluid into the expansion tank, filling hole with help of appropriate accessories such as a funnel and / or beaker. The thermal fluid flows via the expansion tank into the machine, then through the hoses into the external application.
- Start the filling process by selecting the **Main menu point start&stop**. Continue by pressing the sub menu point **start air purge**.  
The filling process is finished when the bath is filled sufficiently (for devices with heating, heating coils have to be beneath the thermal fluid level, corresponds to **minimum bath level / minimum filling**) and no air bubbles should remain in the application (e.g. double jacketed reactor) The controller monitors the filling level and a corresponding message will be displayed in the graphic display.
- Let the **Air purging** program run for a couple of minutes. This will prevent captured air bubbles from remaining in the system which might have been the cause for a later safety switch off of the temperature control.
- Note the volume change of the thermal fluid (especially with oils) in connection with the operating temperature. At the lowest temperature required, the fluid must be above the minimum mark in the sight glass, and it must not overflow at the highest temperature required. In case of over filling, drain off the excess fluid into a suitable container via the expansion tank drain or machine drain (8).

## Draining the machine and an externally closed application



### General

- Before draining the unit, the heat transfer fluid should be at ambient temperature (approx. 20 °C). If not, let the machine run with a set point of approx. 20 °C for a few minutes until the thermal fluid is at a safe temperature.
- Connect one end of a suitable drain hose to the drain of the unit (8), and place the other end into a suitable container (make sure the hose and container materials are compatible with the heat transfer fluid being used).



### Draining

- Open the drain valve (4) if available.
- The heat transfer fluid should flow through the pump case, and drain port into the container.
- Disconnect the hose from the unit's outlet (1).
- Disconnect the hose from the inlet to the unit (2).
- Leave the temperature control device open to dry out for some time (without sealing caps and open drain valve (4)).

## Changing heat transfer fluid / internal cleaning

- After emptying the unit as described in the chapter **Draining the machine and an externally closed application** depending on the thermal fluid, it is possible that remnants of the oil remain in the machine.
- Connect a short hose between the inlet (2) and outlet (1) of the unit.
- When having used silicon oils as thermal fluid, use a suitable solvent (e.g. Mucosol) to clean the internal components such as pump housing, reservoir, etc. Depending on the amount of contamination, it may be necessary to drain the solvent off, and repeat the procedure a number of times with clean solvent.
- Afterwards, leave the temperature control device stand for some time (open all drain valves and have the connections opened).

## **Chapter 4: Interface and software update**

The following chapters are to be found in this section:

- ComG@te
- Digital interface with additional NAMUR commands.

## ComG@te



### Caution!

With plug-in connections subject to a higher voltage than 60 V (AC) and 40 V (DC) there is the risk of receiving an electric shock or of damaging the ComG@te (46). Only components requiring voltages of less than 60 V (AC) and 40 V (DC) should be connected, in order to ensure the safety of the ComG@te.

The ComG@te does not belong to the scope of supply. Proceed as follows, if the ComG@te is not connected. The tempering device must be turned off. Insert the ComG@te into the intended slot. Then turn on the temperature control device. The electronics recognises the new component. The ComG@te is now ready for operation. Note, that you may only exchange the ComG@te when the temperature control device is turned off.

The ComG@te can be extended by means of a connection cable (Order No. #16160). The individual functions, such as PoKo, analogue interface and RS232 / RS485, must be set in the **Main menu**.

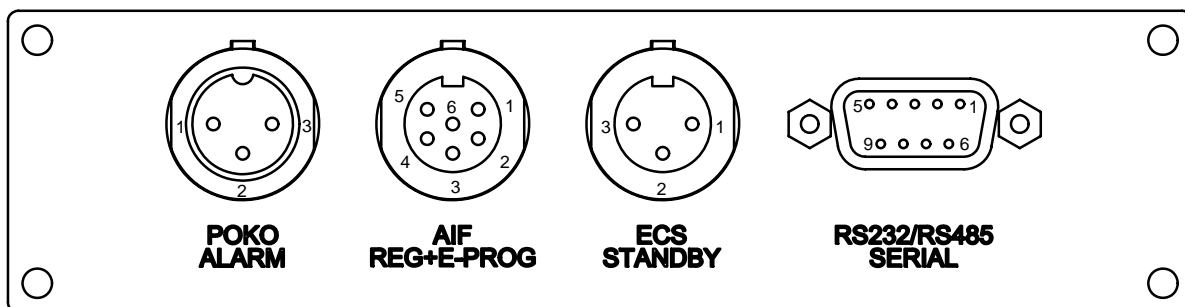

The signal connectors have been designed according to the NAMUR recommendations!

### PoKo (potential free contact) Alarm plug-in connector

Signal contact for external monitoring.

Observe the functional options, which the PoKo provides in the main menu.

The potential free contact (PoKo) signals the condition of the temperature control device by means of the contact position. A closed operating contact means ready status. The operating contact is open in case of a fault or error (this applies to the normally open contact between pin 1 and pin 2).

The connection is designed as a potential free changeover contact.

Normally open contact between pin 1 and pin 2.

Normally closed contact between pin 2 and pin 3.

Contact load: 1A at 24V DC

Only use screened lines!

## AIF Reg-E-Prog Socket

Analogue interface, one input channel (programmable) and 3 output channels.

### **Analogue Interface**

The analogue interface of the ComG@te is programmed in the **Main menu**. Please also read the description concerning the analogue interface in the section of the **ComG@te menu**.

<b>Pin</b>	<b>Signal</b>
1. Current output, T extern	0/4-20 mA or 0-10V
2. Current output, Set point	0/4-20 mA or 0-10V
3. GND for analogue outputs	GND
4. Analogue input (programmable)	0/4-20 mA or 0-10V
5. Current output, free programmable	0/4-20 mA or 0-10V
6. GND for analogue input	GND

## ECS Socket (External Control Signal) Standby

Release signal **ECS** (External Control Signal), for starting / stopping temperature control.

Activation over a potential free contact. The contacts 1 and 3 are bridged internally. ECS becomes electronically active, if E1 and E2 are connected by an external zero potential free contact.

The functionality of the **ECS** is determined in the **ComG@te menu** under the point **ECS Standby**.

The following variants are offered:

- OFF: **ECS** does not have any effect (Factory setting).
- 2<sup>nd</sup> set point: The 2<sup>nd</sup> set point is taken over as soon as **ECS** is activated.
- Standby: **ECS** has effect on temperature control (**ON / OFF**).

<b>Pin</b>	<b>Signal</b>
1,3	E2
2	E1

## RS232 / RS485 Serial Socket

A PC, an SPC or a process control system (PCS) can be connected to this socket, in order to remote control the controller electronics. Alternatively, connecting to a RS485 bus is also possible. Before connecting the line, check and if necessary adjust the settings in the menu **Digit. Interface**.

### **Wiring RS232:**

Pin2	RxD	Receive Data
Pin3	TxD	Transmit Data
Pin5	GND	Signal GND

### **Wiring RS485:**

Pin6	A with 120 Ohm load resistance
Pin7	A
Pin8	B



# Digital Interface with addition NAMUR-Commands

## RS232, Command Syntax, Namur-Commands

### RS232 Commands

The signal interface is carried out over an RS232 Interface. Individual commands have been formatted in accordance with NAMUR recommendations (NE28). To use these commands the following communications protocol should be used:

- 1 Start bit
- 8 Data bits
- 1 Stop bit
- No parity

The data transmission rate is set in the **Main menu**.

**Data flow control:** The commands are not buffered. A new command may be sent as soon as the reply to the previous command has been received. If no reply is expected, then there should be a pause of 500 ms.

**Access method:** Master (Computer / PCS), Slave (Thermostat), the Slave can only be activated by a signal from the master. Required response time: less than 500 ms.

### Further information on Command Syntax:

Commands and parameters should be separated by a space.

- Parameters may be entered as floating point or integer numbers
- The decimal point (code 46) is used in the floating point numbers
- After the comma, two places are permitted (OUT-command)
- A any character after the physical unit (e.g. °C, K, °F) will be ignored
- A positive (+) sign is not required.
- Parameters in an exponential format are not allowed.

### Namur Commands

IN_PV_00	Request Internal (jacket) temperature
IN_PV_02	Request External (process / reactor contents) temperature
IN_SP_00	Request Temperature Set-point
IN_SP_05	Request current Analogue Set-point
OUT_SP_00	Send Set-point xxx.xx
START	Start temperature control
STOP	Stop temperature control

### STATUS

	Single digit
-1	Alarm / Warning
0	OK / standby / manual stop
1	OK Temperature control / air-purging
2	Temperature control stopped remotely
3	Temperature control started remotely

## Example Command

Example for a possible temperature control task:

Please note that the notation `\r\n` means that the CR LF (carriage return / linefeed) is used for the final characters of the command. The data to be transmitted is in `""`.

Master	Slave	Comment
<code>"START\r\n"</code>		Start temperature control
<code>"OUT_SP_00 21.2\r\n"</code>		Change set-point to 21.2 °C
<code>"IN_PV_00\r\n"</code>		Request internal temperature
	<code>"20.5\r\n"</code>	Slave transmits temperature
<code>"IN_PV_02\r\n"</code>		Request process temperature
	<code>"20.5\r\n"</code>	Slave transmits temperature
<code>"STOP\r\n"</code>		Stop temperature control

If a reply is not expected, then a pause of 500 ms should be used.

## **Chapter 5: First aid for a fault condition**

The following sections can be found in this chapter:

- Messages
- Display Error Messages
- Alarm and Warning codes
- Exchange of the electronics / Remote Control
- Maintenance
- Decontamination / Repair
- Cleaning the surfaces
- Plug contacts

## Messages



Messages which occur can be split into Warnings and Alarm messages.

Please note that alarms generally cause the machine to stop temperature control. An alarm message is immediately displayed as text on the graphic display (60).

After the reason for the alarm has been repaired, the machine must be switched off using the main switch (36), and then switched on again in order to reset the alarm.

Warnings do not normally cause the machine to stop temperature control, however they give information concerning critical conditions within the machine or environment. If the conditions leading to the warning message are not improved, then there is a danger that the machine will stop with an alarm, as generally alarm limits are then exceeded.

After the alarm or warning message has been acknowledged, then the graphic display (60) shows in the left upper corner a symbol (a stop sign for alarm messages, a triangle with an exclamation mark for warnings). By turning the rotary knob / key (61), field 11 can be selected by pressing the rotary knob / key (61) a further information window, in which the alarm or warning messages are chronologically shown. Turning the rotary knob / key (61) allows specific messages to be chosen.

# Display Error Messages

## Alarms and Warnings



If an error occurs, the unit will display an alarm or warning message in clear text on the graphic display (60). Each error is allocated an error code.

Errors are separated into three categories:

### Hard alarms (error codes -1 to -1023)

When a hard alarm occurs, temperature control is immediately stopped. The unit must be turned off, using the main switch (36) and the error condition corrected. The unit can then be turned on again. If an alarm occurs during the unit start up and self-test, please contact Huber for advice.

### Soft alarms (error codes -1024 to -2047)

These alarms also cause the temperature control to be immediately stopped. After clearing the error condition temperature control can be restarted without cycling power to the unit.

### Warnings (error codes -2048 to -4095)

These warnings do not stop temperature control, and give important information about the condition of the unit, its environment, or the application. If steps are not made to correct the cause of the warning, there is the risk that an alarm condition may arise, for example if a condition causes the unit to exceed an alarm limit, or temperature.

Once an alarm or warning is acknowledged a symbol will be shown in the upper left corner of the graphic display. A **STOP** sign indicates the presence of an alarm message, a warning triangle (black exclamation mark on a yellow triangle) indicates the presence of a warning message. By lightly touching the symbol on the touch-screen, a list of the stored messages will appear in place of the graphic display. The messages are stored and displayed in time / date order. The rotary knob / key (61) and buttons can be used to step through the messages in order, and display their corresponding text messages.

## System Messages

These messages give the user more general information, such as the attempted entry of an invalid input, or set point. These messages do not generate an alarm. Each message should be acknowledged when it occurs, so as not to cover up the normal display screen. A message does not lead to an interruption of the operating mode which is being performed at the time message is given out.

# Alarm and Warning codes

## Hard Alarms (not resetable)

Code	Message	Action
-1	Over-temperature reached	Please see chapter on setting the over-temperature
-2	Low-level alarm release	Fill with sufficient thermal fluid
-4	actual value internal has exceeded the alarm temperature	Check alarm limits
-5	actual value-internal has exceeded the alarm temperature	Check alarm limits
-6	actual value process has exceeded the alarm temperature	Check alarm limits
-7	Process actual value has fallen below alarm temperature	Check alarm limits
-9	PT100 Internal not connected or faulty	Please contact us or our service partners.
-10	PT100 Process not connected or faulty	Connect a properly functioning external PT100.
-11	PT100 Condensation not connected or faulty	Please contact us or our service partners.
-14	Condensation pressure or temperature too high	Please contact us or our service partners.
-15	Pump speed not correct. Is pump running?	Please contact us or our service partners.
-42	PT100 return sensor not connected or faulty	Please contact us or our service partners.
-43	PT100 Evaporator end not connected or faulty	Please contact us or our service partners.
-48	Evaporation pressure has fallen below allowed minimum value.	Please contact us or our service partners.
-49	Evaporation pressure is too high despite controlling	Please contact us or our service partners.
-50	Superheat is too low for a period	Please contact us or our service partners.
-58	Standby current is too high	Please contact us or our service partners.
-59	Current too high when pump is running	Please contact us or our service partners

-63	<b>Pump pressure</b> has dropped	Activate air purging, degassing program. Please see corresponding chapters in the instruction manual.
-67	No <b>pump pressure</b> seen over a longer time period	Activate air purging, degassing program. Please see corresponding chapters in the instruction manual.
-68	No valid measured values of the <b>internal sensor</b>	Please contact us or our service partners
-69	No valid measured values of the <b>process sensor</b>	Please contact us or our service partners
-74	<b>Difference</b> between control sensor – OT sensor is very large	Improve thermoregulation by increasing pump speed, increase internal cross section of the hoses
-75	<b>Level</b> has dropped: ComG@te	Check level which is monitored by the external float switch
-76	<b>HT Pressostat</b> switch has tripped	Please see that there is sufficient air and water supply
-77	<b>Expansion tank</b> temperature too high	Please see chapter on setting the over-temperature switch.
-86	<b>Current increase</b> measured on heating though NTR open. NTR	Please contact us or our service partners
-87	<b>Current flow</b> when heating is off Opto SSR defect?	Please contact us or our service partners
-88	No sufficient <b>current flow</b> seen for main heating	Please contact us or our service partners
-89	No sufficient <b>current flow</b> seen for fine heating	Please contact us or our service partners
-90	Main heating <b>current</b> too high despite switch off	Please contact us or our service partners
-91	<b>Machine type not recognised</b>	Please contact us or our service partners
-99	<b>Mains isolation relay (NTR)</b> is sticking.	Please contact us or our service partners
-127	Over-temperature sensor 1 <b>short circuit</b>	Please contact us or our service partners
-128	Over-temperature sensor 1 <b>wire break</b>	Please contact us or our service partners
-130	Over-temperature sensor 2 <b>short circuit</b>	Please contact us or our service partners
-133	Over-temperature sensor 3 <b>short circuit</b>	Please contact us or our service partners
-134	Over-temperature sensor 3 <b>wire break</b>	Please contact us or our service partners

-143	The LT Pressostat has operated	Please contact us or our service partners
-144	The MT Pressostat has operated	Please contact us or our service partners
-148	Reporting contact of the pump has triggered	Please contact us or our service partners
-149	Phase Relay for the pump motor has triggered	Right-hand (3 phase, 400V) rotation of the power supply is not available. Please connect to right-hand rotation.
-150	HT Compressor gas outlet temp. sensor faulty	Please contact us or our service partners
-151	LT Compressor gas outlet temp. faulty	Please contact us or our service partners
-152	Thermal contact of the pump has triggered	Possible viscosity problem of the thermal fluid (viscosity is too high)
-153	Temperature of the HT compressor is too high	Please contact us or our service partners
-154	Temperature of the NT compressor too high	Please contact us or our service partners
-155	HT compressor Oil pressure is too low.	Please contact us or our service partners
-201	HT compressor gas outlet temperature to high.	Please contact us or our service partners
-202	LT compressor gas outlet temperature to high.	Please contact us or our service partners
-204	Motor protection switch has triggered by Over-temperature	Please contact us or our service partners
-215	Motor protection switch has triggered by OT in Main-heating.	Please contact us or our service partners
-216	Motor protection switch has triggered by OT in Fine-heating	Please contact us or our service partners
-1027	No pressure increase since pump start. Is pump dry?	Possibly insufficient thermal fluid in the circuit. Fill in thermal fluid and air-purge.
-1029	Level error: Liquid level too low	Possibly insufficient thermal fluid in the circuit. Fill in thermal fluid and air-purge.
-2048	Internal actual value has exceeded alarm temperature	Please contact us or our service partners



-2048	<b>Internal actual value</b> has exceeded alarm temperature	Check alarm limits
-2049	<b>Internal actual value</b> has fallen below alarm temperature	Check alarm limits
-2050	<b>Process actual value</b> has exceeded alarm temperature	Check alarm limits
-2051	<b>Process actual value</b> has fallen below alarm temperature	Check alarm limits
-2052	<b>Analogue input</b> is selected. Signal is faulty. Under/over scale	Please note chapter on: analogue interface
-2053	<b>Analogue input</b> is selected. Signal is faulty. Near limit	Please note chapter on: analogue interface
-2064	<b>Pump pressure</b> is too high	Flow resistor is too high. Improve thermo regulation by e.g. better cross-section enlargement of the hoses
-2068	<b>Temperature difference</b> control sensor, and OT sensor too high	Improve thermo regulation by e.g. higher pump speed, enlarge the cross-section of the hoses
-2072	<b>Over-temperature</b> in expansion tank almost reached	Please note chapter on „setting the over-temperature“
-2075	<b>Actual value</b> lies outside set point range	Check set point limits
-2095	<b>Caution:</b> Level too low. Switch off will take place shortly.	Possibly insufficient thermal fluid in the circuit. Fill in thermal fluid.

## Exchange of the CC Electronics / Remote Control



Disconnect the thermostat from mains power by turning the main switch (36) to **OFF**. Pull out the power plug. In the case of a problem with the electronics, you can exchange these parts yourself or prepare it for use as a remote control. For questions or difficulties please contact our representatives or ourselves.

- Remove the lock (anti-clockwise) for securing the CC-Pilot on the front side of the CC-Pilot, and pull the Pilot carefully up and away.
- Place the replacement CC-Pilot carefully in place and fasten it with the locking (clockwise)

### Remote Control:

An unrigged CC-Pilot Controller can also be used as a remote control. Therefore, mount the connection wire (order no. #16160) between the machine and the CC-Pilot.

## Maintenance



### **Danger!**

Prior to carrying out cleaning on the machine switch off the machine via the mains isolator (36) and disconnect it from the mains.



There are few user-serviceable parts inside the unit. Other than the items listed below, maintenance should be carried out by Huber-trained and authorised personnel.

### **Cleaning cooling fins (for air cooled machines with compressors only)**

To ensure that the temperature control unit will give the maximum cooling power the unit has to be freed from dirt (dust) from time to time. Please provide for an unrestricted air supply (discharge from heat loss, fresh air supply). Keep a distance of 20cm to walls for air cooled units. Identify the position of the air outlet, normally it is to be found at the front, with some other units it can also be found on the side, the rear or under the temperature control unit. Remove the air outlet grill to gain access to the cooling fins. With the help of a brush or vacuum cleaner, you can clean the fins of the black condenser at the back of the cabinet. However, never use pointed objects. Please see that the condenser fins are not damaged or deformed, as this may impair the air current.

### **Cleaning the water filter (for water cooled machines with compressors only)**

Depending on water quality, the filter at the cooling water inlet has to be cleaned regularly. Immediately after the cooling water connection there is the cooling water filter. Close the water supply lines and place a container below the cooling water outlet (27). Use a 17mm spanner (wrench) to remove the filter cover. The metal cooling water filter is underneath the cover, and can be removed and rinsed.



We are pleased to offer service training for users. Please contact Customer Support Team for further details.

## Decontamination / Repair



The user is responsible for making sure that there are no hazardous materials either in or on the unit. The level of decontamination should be appropriate to the amount and type of contaminants on the unit. The user should refer to the appropriate MSDS information for advice.

The decontamination should be done **BEFORE** outside personnel come into contact with the machine, and **BEFORE** the unit is sent out for repair or testing. The unit should be clearly labelled that it has been decontaminated before it is sent.

We have prepared a document to simplify this process. This is available in the appendix, and at our website [www.huber-online.com](http://www.huber-online.com).

### Cleaning the surfaces

A normal steel cleaning spray is suitable for cleaning the stainless steel surfaces. Painted areas should be carefully cleaned with a gentle detergent.

### Plug contacts

Each socket has a protective cap belonging to it. If a connector is not required, then it should be covered with this cap.

## **Chapter 6: Taking the machine out of service**

The following sections can be found in this chapter:

- Decommissioning
- Transport
- Disposal

# Decommissioning

Safety notice and policy



## Caution!

- Injury to persons or property possible:
- Danger of slippage due to contaminated floor and working area.
- Danger of tipping due to insufficient stability.
- Danger of electric shock due to faulty power connection.
- Danger of burns at extreme temperatures if touched.
- Danger of chemical burns of the eyes, skin or airway due to emission of dangerous vapours (with the appropriate thermal fluid).
- Leakage of fluid remnants to be caught in a collecting vessel. Machine and floor contamination to be removed at once!



All safety notices are essential and must be considered when working according to the operating manual!

## Switching off

Set main switch (36) to "0".

Disconnect the thermostat from the power supply.

## Drain out cooling water (only with water cooled machines)

Draining procedure:

Customers drain valves to be closed so that no cooling water flows. Put a collecting vessel under the cooling water connections of the machine. Remove the closing cap on the cooling water drain. The water will begin to drain from the water connections. It is essential that the water is allowed to fully drain out to prevent danger of freezing during storage or transport!



The drained off cooling water can be tipped down the normal drains. The draining of the machine can be accelerated by blowing a compressed air pistol against the cooling water connections.

## **Transport**

The unit is now decommissioned and ready for transportation. The original packing material should be used as far as possible, and the unit must always be transported in the upright position.

Items such as the controller and sight glass should be protected from transport damage. The unit should not be transported on its rollers, or mounting feet. Supports of rectangular wooden beams appropriate for the weight should be used even when transported on a pallet. When shipping the unit on a pallet, it should be braced on four sides using wood or other suitable materials. Extra bracing and banding should be made according to the weight of the unit. Extra materials such as plastic wrap / sheeting, cardboard, and banding should be used as necessary.

## **Disposal**

Thermal fluid which has spilled or leaked must be correctly disposed of.

To minimise environmental pollution, please dispose of old temperature control machines only via suitably licenced and experienced disposal or recycling companies.

# BESTÄTIGUNG / CONFIRMATION



An / To:

**Huber Kältemaschinenbau GmbH**  
Werner-von-Siemens-Str. 1  
77656 Offenburg

Von / from:

<b>Firma / company:</b> _____	<b>Betreiber / responsible body:</b> _____
<b>Strasse / street:</b> _____	<b>Name / name:</b> _____
<b>Ort / city:</b> _____	<b>Funktion / function:</b> _____
<b>Tel.:</b> _____	<b>Gebäude / building:</b> _____
<b>Fax:</b> _____	<b>Raum / room:</b> _____
<b>Email:</b> _____	

**Hiermit bestätigen wir, dass nachfolgend aufgeführtes HUBER- Temperiergerät:**  
We hereby confirm that the following HUBER-equipment:

UNISTAT  UNICHILLER  MINISTAT  CC  \_\_\_\_\_

Typ / Type: \_\_\_\_\_  
Serien-Nr. / Serial no: **S** \_\_\_\_\_

**mit folgendem Thermofluid betrieben wurde**  
Was used with the below mentioned heat transfer fluid

\_\_\_\_\_

Beachten Sie bitte bei der Verwendung fremder Temperiermedien:  
Durch die Vielzahl unterschiedlicher Thermofluide sind wir gezwungen vor Beginn der Reparatur die Geräte zu spülen. Die dabei entstehenden Kosten müssen wir Ihnen in Rechnung stellen. Sie können die für Sie anfallenden Kosten niedrig halten, wenn sie das Gerät vor der Rücksendung mit Ethanol spülen. Vielen Dank!

Please note that if you're using none Huber heat transfer fluids we have to flush the system before we start with your repair. The resulting costs have to be added onto your bill. You can reduce your repair costs by flushing your system with ethanol before return. We appreciate your help!

**Darüber hinaus bestätigen wir, dass das oben aufgeführte Gerät sorgfältig gereinigt wurde, die Anschlüsse verschlossen sind und sich weder giftige, aggressive, radioaktive noch andere gefährliche Medien in oder am Gerät befinden.**

Additionally we confirm that the above mentioned equipment has been cleaned, that all connectors are closed and that there are no poisonous, aggressive, radioactive or other dangerous substances on or inside the equipment.

Stempel  
Seal

Ort/ Datum  
City/ date

Betreiber  
responsible body

## EU declaration of conformity

We hereby declare that the design of the appliance described below complies in the version sold by us with the relevant EU guidelines, also listed below. Implementing modifications not approved by us will invalidate this declaration.

Designation: Circulation Thermostat  
Type:  
Serial Number:  
Order number:

### Relevant EU directives:

2006/95/EG (Low-Voltage directive)

2004/108/EC (Electromagnetic Compatibility)

### Relevant harmonized standards under the directives indicated above:

EN 61010-1: 2002  
EN 61010-2-10: 2004  
EN 61326: 2004

### Further national standards:

DIN 12876-1  
DIN 12876-2  
DIN 12876-3

Offenburg, 12 Januar 2010

Peter Huber  
Kältemaschinenbau GmbH

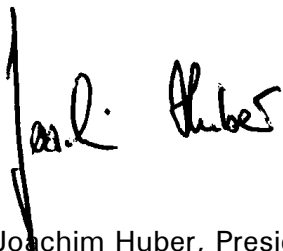
A handwritten signature in black ink, appearing to read 'Joachim Huber', is written over a vertical line that extends from the signature down to the printed name below.

Joachim Huber, President