



High Pressure Equipment

Low Pressure Valves, Fittings and Tubing

Taper Seal and NPT -10,000 and 15,000 psi service

High Pressure Equipment Company has developed the Taper Seal and NPT lines of products to assure safe and easy plumbing through 15,000 psi. These needle valves, fittings, line filters, check valves, safety heads, rupture discs and tubing are engineered and manufactured to the highest standards of repeatable quality. The reliable performance of these products has made HiP one of the world's leading suppliers of elevated pressure components.

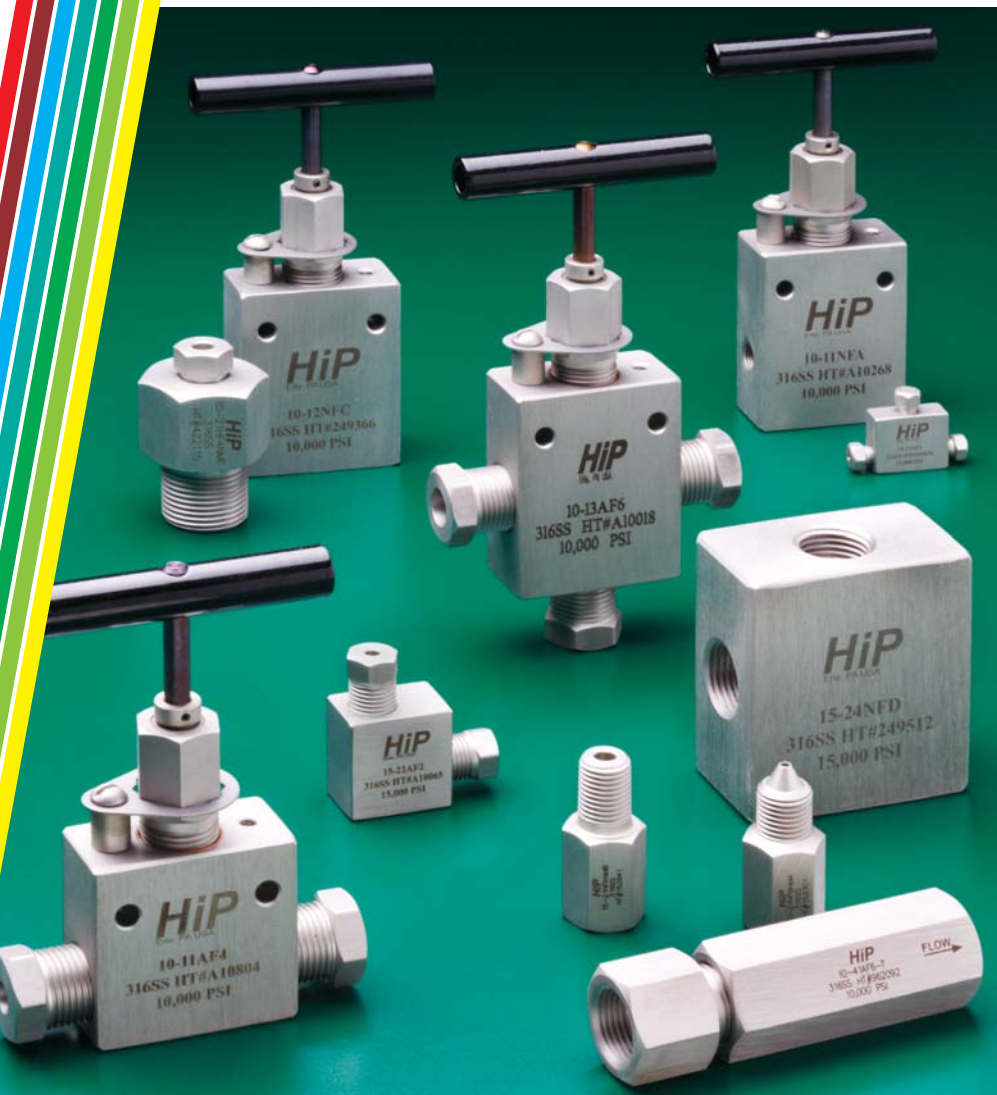

Index - Taper Seal Page

Valves	2.2-2.3
Fittings	2.4
Line Filters & Check Valves	2.5
Safety Heads	2.6
Rupture Discs	2.7
Tubing	2.7
Connection Details	2.A
	Appendix

Index - NPT Page

Valves	2.11-2.12
Fittings	2.13
Couplings, Bulkheads & Caps . . .	2.14
Line Filters & Check Valves	2.15
Safety Heads & Rupture Discs . .	2.16



High Pressure Equipment

Taper Seal Needle Valves 10,000 and 15,000 psi service

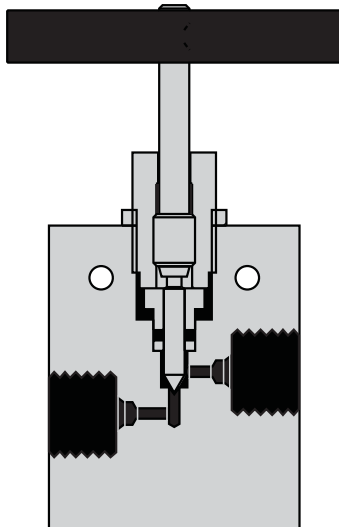

AF1 ($\frac{1}{16}$ ") and AF2 ($\frac{1}{8}$ ")
15,000 psi

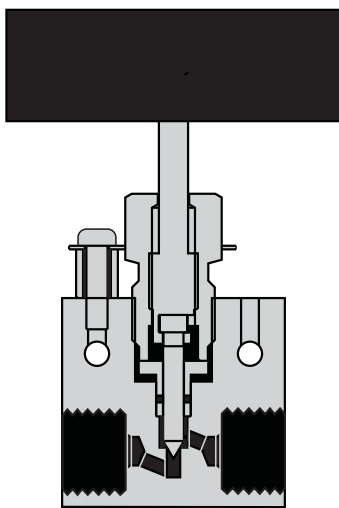

AF4 ($\frac{1}{4}$ ") and AF6 ($\frac{3}{8}$ ")
10,000 psi

Compression type tubing connections for $\frac{1}{16}$ " , $\frac{1}{8}$ " , $\frac{1}{4}$ " , and $\frac{3}{8}$ " O.D. tubing. Requires no special tooling for tubing preparation (simply cut off, deburr, and insert tubing into connection). Connection details are shown on page 2.A.

Non-rotating tip stems are standard for on-off service and ensure long life on valve seats. Regulating tip stems are available at no additional cost, add - REG to the catalog number.

Glands and sleeves are supplied with each valve unless otherwise requested (glands and sleeves shown on pages 2.4 and 2.A).

Materials include high tensile type 316 stainless steel for the valve body and hardened 17-4PH stainless steel lower section stem.

Packing is Teflon (450°F) standard, with optional Viton (350°F), BUNA-N (200°F) or Grafoil (650°F) available at no additional cost.

Air operators for remote control operation are available for all valves. (Refer to Air Operator section of catalog for additional data).

Valve Features

- Non-rotating stem tips
- Packing below stem threads
- Type 316 ss high tensile bodies
- Positive gland lock device
- No stem adjustment needed
- Black T-handles or choice of 4 colors
- Tube sizes $\frac{1}{16}$ " through $\frac{3}{8}$ "

Taper Seal Valves

Two Way Straight Valves

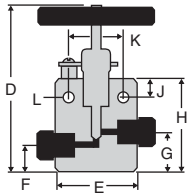

Tubing	Catalog No.	psi	Connection	Orifice	D	E	F	G	H	J	K	L	Thickness
1/16" O.D.	15-11AF1	15,000	AF1	0.052"	2 1/2"	1 1/8"	1/4"	13/32"	1 1/8"	5/16"	3/4"	9/64"	1/2"
1/8" O.D.	15-11AF2	15,000	AF2	1/16"	3 1/8"	1 1/2"	11/16"	15/16"	1 13/16"	5/16"	7/8"	9/64"	3/4"
1/4" O.D.	10-11AF4	10,000	AF4	1/8"	4 5/8"	2"	1/2"	1/2"	1 7/8"	1/2"	1 3/8"	7/32"	1"
3/8" O.D.	10-11AF6	10,000	AF6	1/8"	4 5/8"	2"	1/2"	1/2"	1 7/8"	1/2"	1 3/8"	7/32"	1"

Two Way Angle Valves

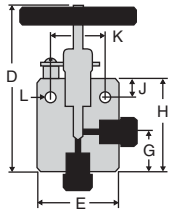

Tubing	Catalog No.	psi	Connection	Orifice	D	E	F	G	H	J	K	L	Thickness
1/16" O.D.	15-12AF1	15,000	AF1	0.052"	2 7/8"	1 1/8"	—	21/32"	1 9/8"	5/16"	3/4"	9/64"	1/2"
1/8" O.D.	15-12AF2	15,000	AF2	1/16"	3 1/8"	1 1/2"	—	15/16"	1 13/16"	5/16"	7/8"	9/64"	3/4"
1/4" O.D.	10-12AF4	10,000	AF4	1/8"	5 3/16"	2"	—	1 1/16"	2 7/16"	1/2"	1 3/8"	7/32"	1"
3/8" O.D.	10-12AF6	10,000	AF6	1/8"	5 3/16"	2"	—	1 1/16"	2 7/16"	1/2"	1 3/8"	7/32"	1"

Three Way Valves / Two Pressure Connections

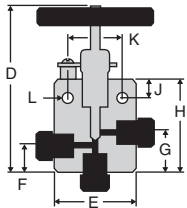

Tubing	Catalog No.	psi	Connection	Orifice	D	E	F	G	H	J	K	L	Thickness
1/16" O.D.	15-13AF1	15,000	AF1	0.052"	2 3/4"	1 1/8"	1/2"	21/32"	1 9/8"	5/16"	3/4"	9/64"	1/2"
1/8" O.D.	15-13AF2	15,000	AF2	1/16"	3 1/8"	1 1/2"	11/16"	15/16"	1 13/16"	5/16"	7/8"	9/64"	3/4"
1/4" O.D.	10-13AF4	10,000	AF4	1/8"	5 3/16"	2"	1/2"	1 1/16"	2 7/16"	1/2"	1 3/8"	7/32"	1"
3/8" O.D.	10-13AF6	10,000	AF6	1/8"	5 3/16"	2"	1/2"	1 1/16"	2 7/16"	1/2"	1 3/8"	7/32"	1"

Three Way Valves / One Pressure Connection

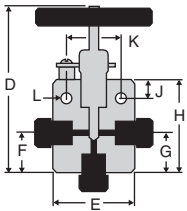

Tubing	Catalog No.	psi	Connection	Orifice	D	E	F	G	H	J	K	L	Thickness
1/16" O.D.	15-14AF1	15,000	AF1	0.052"	2 3/4"	1 1/8"	21/32"	21/32"	1 9/8"	5/16"	3/4"	9/64"	1/2"
1/8" O.D.	15-14AF2	15,000	AF2	1/16"	3 1/8"	1 1/2"	15/16"	15/16"	1 13/16"	5/16"	7/8"	9/64"	3/4"
1/4" O.D.	10-14AF4	10,000	AF4	1/8"	5 3/16"	2"	1 1/16"	1 1/16"	2 7/16"	1/2"	1 7/8"	7/32"	1"
3/8" O.D.	10-14AF6	10,000	AF6	1/8"	5 3/16"	2"	1 1/16"	1 1/16"	2 7/16"	1/2"	1 3/8"	7/32"	1"

Three Way / Two Stem Connection Valves

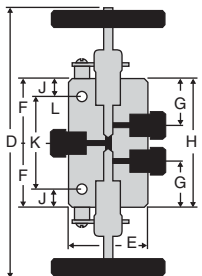

Tubing	Catalog No.	psi	Connection	Orifice	D	E	F	G	H	J	K	L	Thickness
1/16" O.D.	15-15AF1	15,000	AF1	0.052"	4 3/4"	1 1/8"	1"	23/32"	2"	5/16"	1 3/8"	9/64"	1/2"
1/8" O.D.	15-15AF2	15,000	AF2	1/16"	5"	1 1/2"	1 1/4"	7/8"	2 1/2"	5/16"	1 7/8"	9/64"	3/4"
1/4" O.D.	10-15AF4	10,000	AF4	1/8"	8 7/8"	2"	1 11/16"	1 3/16"	3 3/8"	1/2"	2 3/8"	7/32"	1"
3/8" O.D.	10-15AF6	10,000	AF6	1/8"	8 7/8"	2"	1 11/16"	1 13/16"	3 3/8"	1/2"	2 3/8"	7/32"	1"



High Pressure Equipment

Glands/Sleeves/Plugs Elbows/Tees/Crosses

A complete range of elbows, tees, and crosses is available for all of the tubing connection sizes. Material is high tensile 316 stainless steel. Standard tubing glands and sleeves are furnished unless otherwise specified.

Connection Components

Catalog No.	Tube Size	Gland	Catalog No.	Tube Size	Sleeve	Catalog No.	Tube Size	Plug
15-2AM1	1/16"		15-2A1	1/16"		15-7AM1	1/16"	
15-2AM2	1/8"		15-2A2	1/8"		15-7AM2	1/8"	
10-2AM4	1/4"		10-2A4	1/4"		10-7AM4	1/4"	
10-2AM6	3/8"		10-2A6	3/8"		10-7AM6	3/8"	

Taper Seal Elbows

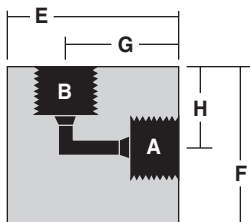

Catalog No.	Pressure Rating psi	Connections	A-B	E	F	G	H	Thickness
15-22AF1	15,000	1/16" O.D. TUBE	AF1	3/4"	3/4"	9/16"	9/16"	3/8"
15-22AF2	15,000	1/8" O.D. TUBE	AF2	1 1/8"	1 1/8"	3/4"	3/4"	3/4"
10-22AF4	10,000	1/4" O.D. TUBE	AF4	1 1/2"	1 1/2"	1"	1"	1"
10-22AF6	10,000	3/8" O.D. TUBE	AF6	1 1/2"	1 1/2"	1"	1"	1"

Taper Seal Tees

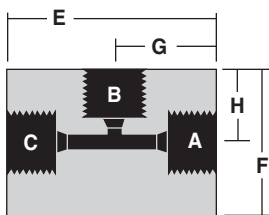

Catalog No.	Pressure Rating psi	Connections	A-B-C	E	F	G	H	Thickness
15-23AF1	15,000	1/16" O.D. TUBE	AF1	1"	3/4"	1/2"	9/16"	3/8"
15-23AF2	15,000	1/8" O.D. TUBE	AF2	1 1/2"	1 1/8"	3/4"	3/4"	3/4"
10-23AF4	10,000	1/4" O.D. TUBE	AF4	2"	1 1/2"	1"	1"	1"
10-23AF6	10,000	3/8" O.D. TUBE	AF6	2"	1 1/2"	1"	1"	1"

Taper Seal Crosses

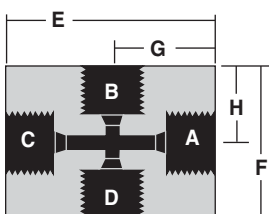

Catalog No.	Pressure Rating psi	Connections	A-B-C-D	E	F	G	H	Thickness
15-24AF1	15,000	1/16" O.D. TUBE	AF1	1"	1"	1/2"	1/2"	3/8"
15-24AF2	15,000	1/8" O.D. TUBE	AF2	1 1/2"	1 1/2"	3/4"	3/4"	3/4"
10-24AF4	10,000	1/4" O.D. TUBE	AF4	2"	2"	1"	1"	1"
10-24AF6	10,000	3/8" O.D. TUBE	AF6	2"	2"	1"	1"	1"

Line Filters

The line filters as shown utilize sintered stainless steel filter discs (AF2 & AF1 – 3 pc./set, AF4 & AF6 – 4 pc./set). Porosities are available as per the chart to the right. If not otherwise specified, 100 micron filter discs are supplied. (One micron = 0.001 millimeters). Material of bodies and end covers is high tensile 316 stainless steel. Standard tubing glands and sleeves are provided unless otherwise specified.

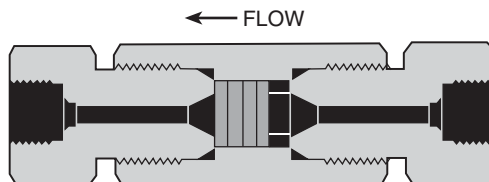

Catalog No.	Pressure Rating psi	Connections	Length	Hex Size	Micron Size Filter Available					
					0.5	2	5	10	40	100
15-51AF1	15,000	1/16" TAPER SEAL	3 1/8"	3/4"	●	●	●	●	●	●
15-51AF2	15,000	1/8" TAPER SEAL	3 1/8"	3/4"	●	●	●	●	●	●
10-51AF4	10,000	1/4" TAPER SEAL	5 1/4"	1 3/8"	●	●	●	●	●	●
10-51AF6	10,000	3/8" TAPER SEAL	5 1/4"	1 3/8"	●	●	●	●	●	●

Ball Check Valves

Ball type check valves insure flow in one direction only. Material for bodies, balls, and covers is high tensile 316 stainless steel. Standard tubing glands and sleeves are provided unless otherwise specified.

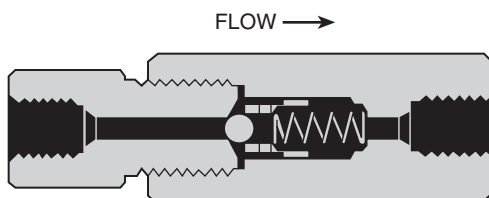

Catalog No.	psi	Connections	Length	Hex
15-41AF1	15,000	1/16" TAPER SEAL	3 1/8"	1"
15-41AF2	15,000	1/8" TAPER SEAL	3 9/16"	1"
10-41AF4	10,000	1/4" TAPER SEAL	3 7/8"	1"
10-41AF6	10,000	3/8" TAPER SEAL	3 7/8"	1"

Soft Seat Check Valves

Soft seat check valves insure flow in one direction only and can be mounted in any position. These are highly reliable for both gas and liquid service. Standard O-ring (soft seat) material for the sealing surface is Buna-N (nitrile) with other materials including Teflon and Viton available on request. Temperature is limited by the choice of O-ring material. Material of all other parts is high tensile 316 stainless steel. Standard glands and sleeves are provided unless otherwise specified.

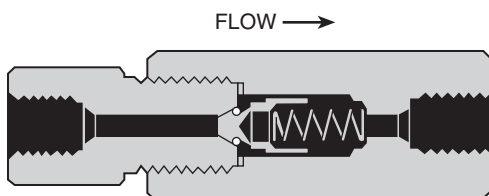

Catalog No.	psi	Connections	Length	Hex
15-41AF1-T	15,000	1/16" TAPER SEAL	3 1/2"	1"
15-41AF2-T	15,000	1/8" TAPER SEAL	3 1/2"	1"
10-41AF4-T	10,000	1/4" TAPER SEAL	3 7/8"	1"
10-41AF6-T	10,000	3/8" TAPER SEAL	3 7/8"	1"



High Pressure Equipment

Safety Heads

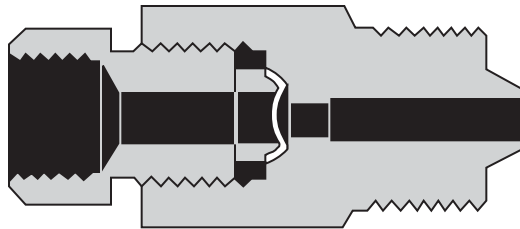

A choice of three safety head designs is available: male inlet, female inlet (straight), and tee type. The male inlet design can be inserted directly into the tubing connections of valves and various fittings such as tees and crosses, or located in pressure vessels.

Outlet connections on all sizes are $\frac{3}{8}$ " pipe (NPT). This outlet may be connected to a suitable discharge line to vent pressure to a safe location in the event of bursting of the rupture disc. Torque required for sealing rupture discs will range from 40 to 60 foot pounds, depending upon pressure and media being used.

Material of bodies and hold down nuts is high tensile 316 stainless steel. Hold down rings are hardened 17-4PH stainless steel. Standard tubing glands and collars (sleeves) are provided unless otherwise specified.

Note: Rupture discs are **not** included and must be ordered as a separate item.



Male Inlet Safety Heads

Catalog No.	Pressure Rating psi	Inlet Connection	Length	Hex Size
10-61AM4	10,000	$\frac{1}{4}$ " TAPER SEAL	2 $\frac{1}{8}$ "	1"
10-61AM6	10,000	$\frac{3}{8}$ " TAPER SEAL	2 $\frac{1}{8}$ "	1"

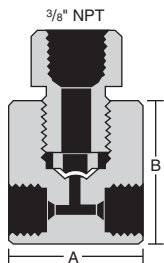

Tee Type Safety Heads

Catalog No.	Pressure Rating psi	Inlet Connection	A	B	Thickness
15-63AF1	15,000	$\frac{1}{16}$ " TAPER SEAL	1 $\frac{1}{8}$ " HEX	1 $\frac{3}{8}$ "	1 $\frac{1}{8}$ "
15-63AF2	15,000	$\frac{1}{8}$ " TAPER SEAL	1 $\frac{1}{2}$ "	1 $\frac{1}{2}$ "	1"
10-63AF4	10,000	$\frac{1}{4}$ " TAPER SEAL	2"	1 $\frac{3}{4}$ "	1"
10-63AF6	10,000	$\frac{3}{8}$ " TAPER SEAL	2"	1 $\frac{3}{4}$ "	1"



Female Inlet (Straight) Safety Heads

Catalog No.	Pressure Rating psi	Inlet Connection	Length	Hex Size
15-61AF1	15,000	$\frac{1}{16}$ " TAPER SEAL	1 $\frac{7}{8}$ "	1"
15-61AF2	15,000	$\frac{1}{8}$ " TAPER SEAL	1 $\frac{7}{8}$ "	1"
10-61AF4	10,000	$\frac{1}{4}$ " TAPER SEAL	1 $\frac{7}{8}$ "	1"
10-61AF6	10,000	$\frac{3}{8}$ " TAPER SEAL	1 $\frac{7}{8}$ "	1"

Rupture Discs

1/4" Angled Seat

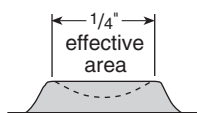

SPECIAL DISCS are available on special order for pressure ranges not shown above and in numerous materials and coatings. Consult factory for price and delivery.

Standard rupture discs are available from stock in burst pressures as listed in the chart below. Taper seal pressures are shaded. These discs are 316 stainless steel (except for 1000 psi which are inconel) and may be used with any of the safety heads shown. Note that these rupture discs are supplied with a tolerance of plus 6% and minus 3% of specified burst pressure. Samples of each batch are then tested and the actual average burst pressure is stamped on an accompanying metal tag. Factors influencing rupture disc life include corrosion, metal fatigue, and cyclic effects. Periodic replacement is recommended to prevent premature failure.

Standard Burst Pressures (in psi at 72°F)

1,000	3,000	5,000	7,000	9,000	11,000	17,500	25,000	37,500	55,000
1,500	3,500	5,500	7,500	9,500	11,500	18,000	27,000	40,000	60,000
2,000	4,000	6,000	8,000	10,000	12,500	20,000	30,000	45,000	65,000
2,500	4,500	6,500	8,500	10,500	15,000	22,500	35,000	50,000	

High Pressure Tubing

Tubing is cold drawn, seamless, and is supplied in the 1/8 hard condition (not annealed). Tensile strength is approximately 40 percent higher than that of annealed tubing. All tubing is manufactured in strict accordance with High Pressure Equipment Company specifications to insure tolerances and bore quality. Tubing is stocked in lengths of 18 to 22 feet but may be ordered in shorter lengths with **no additional cutting charge**.

Note: The 1/16" and 1/8" O.D. tubing sizes may be coiled for shipment. Larger sizes must be shipped in straight lengths.



	Tubing Size	Working Pressure psi	Type of Connection Used	Material	Catalog Order Number
1/16"	1/16" O.D. x 0.006" I.D.	15,000	1/16" TAPER SEAL (AF1)	316 SS	15-9A1-006
	1/16" O.D. x 0.030" I.D.				15-9A1-030
1/8"	1/8" O.D. x 0.060" I.D.	15,000	1/8" TAPER SEAL (AF2)	316 SS	15-9A2
1/4"	1/4" O.D. x 1/8" I.D.	10,000	1/4" TAPER SEAL (AF4)	316 SS	10-9A4-316
				304 SS	10-9A4-304
3/8"	3/8" O.D. x 1/4" I.D.	10,000	3/8" TAPER SEAL (AF6)	316 SS	10-9A6-316
				304 SS	10-9A6-304



High Pressure Equipment

Taper Seal Connections

10,000 and 15,000 psi service

Taper Seal connections are available for $\frac{1}{16}$ " , $\frac{1}{8}$ " , $\frac{1}{4}$ " , and $\frac{3}{8}$ " O.D. tubing. No special tubing preparation is required – simply cut tubing to desired length, deburr and assemble.

The $\frac{1}{8}$ " , $\frac{1}{4}$ " , and $\frac{3}{8}$ " sizes utilize a two-piece sleeve which is supplied partially assembled. When the connection is assembled, the outer sleeve portion is permanently compressed over the inner portion to rigidly lock the sleeve onto the tubing. Note that the sleeve is not forced to bite into the tubing, but rather is clamped onto the tubing much like a machine collet.

Pressure ratings.

The $\frac{1}{16}$ " and $\frac{1}{8}$ " O.D. tubing size connections are rated to 15,000 psi working pressure.

The $\frac{1}{4}$ " and $\frac{3}{8}$ " O.D. sizes are rated to 10,000 psi working pressure.

Easy make-up connections.

One of the popular benefits of taper seal connections is that it is very easy to determine when the connection is "tight enough" during initial assembly. Simply rotate the tubing gland into the connection until you feel a "bottoming out" or "dead stop" of the wrench. This signals that the connection has been properly made.

A commercial thread lubricant is highly recommended to facilitate initial makeup of the connection, but such lubrication may be removed afterwards if desired. The Taper Seal connection can be disassembled and then reassembled an indefinite number of times.

Standard material for the gland is Type 316 stainless steel. The inner portion of the two-piece sleeve is Type 316 stainless steel. The non-wetted outer sleeve portion is zinc plated alloy steel. (Note that the $\frac{1}{16}$ " O.D. size is a one-piece sleeve design) in Type 316 stainless steel.

Tubing glands and sleeves are provided with all valves and fittings unless otherwise requested. (See chart at right for size details and catalog numbers).

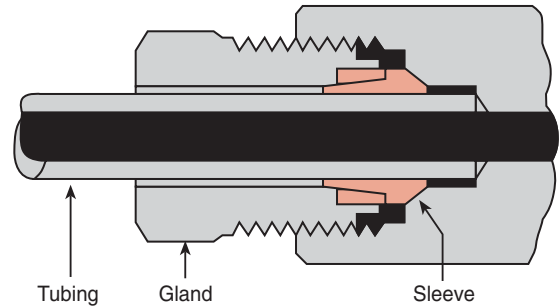

	15,000 psi		10,000 psi	
	AF1 <i>1/16" O.D. Tubing</i>	AF2 <i>1/8" O.D. Tubing</i>	AF4 <i>1/4" O.D. Tubing</i>	AF6 <i>3/8" O.D. Tubing</i>
Female Opening Detail				
Gland				
Sleeve				
Plug				